

AD Connect

Discover RFID label
technology

View our application-
specific portfolios,
now with flexible
packaging



Functional Packaging:
Reclosure, Flexpak™
+ more

Features

Delighting Today's On-The-Go Consumer

How Functional Packaging Adds Value, Transforming Buying Decisions

7

The Functional Packaging Value Chain

How You Fit, What You Need, Who to Partner With

12

The Intelligent Label Transformation

More industries are poised to increase their use of label constructions enhanced with RFID technology

14

Highlights

AD Perspective 4
Keeping Your Presses Going

AD Insights 10
The Emotional Appeal of Packaging

AD Teams 16
Technical Leaders

AD Sustainability 18
ClearIntent™ Portfolio

AD Differentiation + Growth 28
Portfolios, Engineered Solutions, Technical Leaders

Portfolios

Apparel	30	Lawn & Garden	45
Appliance	31	Lay-Flat Liner	46
Automotive	32	Natural Kraft	35
Bumper Sticker	35	Outdoor	47
Candle & Soap	34	Overlaminates	
Cover-up	36	Overlaminates	57
Drum	38	Piggy Back	37
Fas-Flex™	40	Reclosure	50
Fire Extinguisher	40	Removables	51
Flexible Packaging	48	Safety & Warning	56
Food Safety & Promotion	41	Security	49
Holographic	42	Tag Stock	58
HVAC	43	Transfer Tape	58
Kiddie Sticker	44	Single Slit Roll	59
		Mix & Match™	60



8



14



16



19



We're Working to Keep Your Presses Going

Nick Tucci,
Vice President and General Manager,
Label and Graphics Materials,
North America



The past year has seen growing consumer demand, driven by increasing confidence and strong underlying employment. Both the U.S. and global economy expanded in 2017 at their fastest rate since 2014. I am happy with the state of the economy, and optimistic about future growth. I hope you are, too.

At the same time, I have had concerns about significant disruptions to our industry's supply chain. These disruptions have been the result of multiple, disconnected factors, including severe weather, environmental regulations, and changes within the trucking industry.

Historic Weather in the U.S.

The spring and summer of 2017 were tough for eastern Texas and the Gulf coast. The region was hit with a series of historic severe weather events, including Hurricane Harvey. Rightfully, the top priority was the preservation of life and property. But the severe weather did impact petroleum processing. While this was a short-term issue, it did have a very noticeable downstream effect on the availability and pricing of raw materials used in the manufacture of films and adhesives.

Stricter Environmental Controls in China

Around that time, on the other side of the world, the Chinese government began targeting chemical plants with stricter environmental controls. According to Forbes, 40 percent of China's factories (across all industries) were shut down at some point for environmental inspection. Again, a downstream impact: Many raw materials used in both adhesive and paper production are made in China.

An Evolution in Shipping and Logistics

Transportation, meanwhile, has been addressing its own challenges. The American Trucking Association reported last October that the freight industry was facing a shortage of 50,000 drivers by the end of the year. This issue has been exacerbated not only by overall demand, but also by freight companies' need to comply with new federal regulations. The latter has driven cost increases of spot loads and has lengthened some shipping times.

Minimizing the Effects of these Disruptions

Sure enough, we started to feel the combined effects of these disruptions in the fourth quarter of 2017. Just as orders were being processed, many suppliers started saying that shipments were delayed, that materials would cost more, or that materials were simply unavailable.

With our size and scale, Avery Dennison has been able to minimize—though not eliminate—these effects. In some cases, we have been able to absorb the added costs of raw materials and transportation. We have also worked to expand the breadth of our supply chain to help ensure the continued availability of raw materials. Even with these efforts, however, I know that some orders have taken longer than expected. I thank you for your patience and understanding as we work to drive business continuity and stability.

Moving Forward

As the economy becomes increasingly global, new and different opportunities become available to our industry. With that, however, comes a more complex and challenging-to-manage supply chain. We cannot predict (not with certainty, at least) the impact of weather or government activity.

What we can predict and promise is that Avery Dennison will continue to be proactive. We will leverage the advantages of our global footprint, continue to make investments to expand our capabilities and supply chain. Most importantly, we will continue to learn, adapt and be agile in how we serve our industry. We have a world-class procurement team and I am confident that if anyone can help you keep your presses going, it is Avery Dennison.

Once again, I thank you for your patience and understanding as we navigate sustained turbulence in our Industry. The challenges have taught us to think creatively, persevere through the adversity and listen intently to our customers. I also welcome your feedback on these challenges—look for a version of this article on my [LinkedIn profile](#). Connect with me there, and please share your comments and questions. Thank you for your business, your continued confidence in our team and trust in Avery Dennison. **AD**



Delighting Today's On-The-Go Consumer

How Functional Packaging Adds Value, Transforming Buying Decisions

When it comes to food shopping, today's families are focused on convenience, portability, health, and quality. They're also time-pressed like never before, as they work to juggle the demands of family, work, and other commitments.

All this creates opportunities for packaging and label converters serving brand owners in the fast-moving consumer goods segment. It's an opportunity to offer smarter packaging that helps people save time and effort, and be confident in the freshness of their purchases.

"Functional packaging" is the name we give that opportunity. A new and fast-growing phenomenon, it's helping brand owners add value to existing products while transforming the way consumers make decisions at the point of sale.



↑ According to packagingnews.co.uk, consumers expect their product to be almost as fresh as the day it left the factory. That's just one reason why they're drawn to peel and reseal packaging at the grocery store.

Functional Packaging Defined

Functional packaging goes beyond simple product containment, offering consumer benefits such as extended shelf life or easy open/close. The category includes flexible pouches and stickpacks, and may utilize pressure-sensitive reclosures, RFID technology, and/or security (tamper-evident, anti-counterfeit) materials.

By delivering greater utility, functional packaging increases the overall value of a product while enhancing the consumer's experience. According to a recent study by the Avery Dennison market research department (see article on [page 10](#)), we've even seen some consumers are willing to pay more for functional packaging's benefits.

A Fast-Growing Segment

Functional packaging is becoming increasingly common, and is expected to continue to grow over the next few years. According to Euromonitor, pressure-sensitive reclosures are predicted to be the fastest growing closure type globally, with a CAGR of 6 percent through 2020. Meanwhile, Micromarket Monitor predicts the U.S. flexible pouch market will grow to \$29.64 billion by 2021. That's an estimated CAGR of 5 percent.

According to Euromonitor International, 190 billion retail units in the food industry will transition to flexible packaging in the next three to five years.

Multiple consumer purchasing trends are driving this growth.

The Need for Convenience and Portability

More than ever before, shoppers expect convenience. According to recent insights from Avery Dennison and Lux Research, consumers are willing to pay 11 percent more for each added layer of convenience.

The result is brand owners are beginning to pay greater attention to consumers' needs to use and store the product at home, than to retailers' needs to display the product on store shelves.

A walk through any grocery store will likely reveal multiple examples of this trend. For instance, dry foods such as rice, pasta, tea, coffee, and cookies are now often packaged in reclosures. These provide convenient, easy, peel-and-reseal functionality. Another example are soup mixes, seasonings, dry powders, and sauces being sold in flex packs. They're small, easy to open, light weight, leak-proof for hard-to-hold ingredients, and easy to store with less packaging waste. Functional packaging also allows consumers to extract every last little bit, smidge or drop.

On-the-go snacks, or personal care travel sizes are adding another layer of convenience for time-strapped consumers.



Another factor driving the growth of functional packaging is consumers' demand for portability. This is especially true for home and personal care products, where travel size and

single-use, easy-open/easy-storage packages are in high demand.

In food and beverage, stickpacks are empowering consumers to toss a coffee, lemonade or other favorite beverage into a purse or gym bag. Using visibly less material than traditional packets, stickpacks also appeal to the consumer's ever-growing desire to produce less waste.

Freshness and Safety

According to a 2017 Reuters/Ipsos survey, many consumers are trying to eat foods that are healthier, fresher, and unprocessed. It's probably no wonder, then, that produce and other fresh foods are now driving total store sales.

Shoppers in search of freshness are looking for visual cues. They expect to see freshness, especially for fruits and vegetables. They trust their eyes to confirm ripeness, plumpness, and color.

Brand owners, who understand consumers will pay more for prolonged shelf life, are also focused on freshness. They're increasingly using technology like RFID tags to track shipment time and food expiration dates through the entire supply chain, helping them better manage their inventories and avoid spoilage.

In addition, functional packaging can allow brand owners and consumers alike to be even more confident the product on the store shelf is authentic and safe. RFID labels and tamper-evident seals have all been drafted into the front lines of the fight against counterfeiting in the beauty segment. These features reinforce quality and enhance safety.

According to CBS News, U.S. custom agents seized more than 2,000 shipments of counterfeit beauty products last year alone, costing the cosmetic industry about \$75 million.

Added Value, Added Opportunity

Packaging is undergoing a broad transformation. Consumers expect more convenience, freshness, portability, and confidence in the products they buy. It follows that brand owners realize they can add value by rethinking and redesigning their packaging.

This, of course, represents an opportunity for converters. Success in functional packaging will go to those who are ready and willing to learn about new technologies, who understand how those technologies are being used in the segments they serve, and who reach out to brand owners to explore the possibilities.

The Time Is Now

Whether you're new to functional packaging, or interested in increasing your share of business with this growing segment, turn to Avery Dennison. We offer the business development and technical/application support you need to take the next steps.

Contact your Avery Dennison sales representative, or visit label.averydennison.com. **AD**

The Emotional Appeal of Functional Packaging

Focus groups provide key insights



The Avery Dennison Market Research Department recently conducted a series of focus groups to better understand consumers' emotional response to functional packaging.



A total of 16 consumers were split into four panels. They represented a range of demographics, including age and gender.

The panelists were presented with dry foods, fresh foods, and home and personal care products. The same products were available in “traditional” packaging, as well as functional packaging like reclosures and flexible packaging highlighted in the feature story in this issue ([see page 7](#)). The panelists were asked to select their preferred packaging option for each product category, and share how they felt along with their likes and dislikes.

Overall, we learned consumers appreciate the ease, convenience, integrity, and lifestyle-compatibility delivered by functional packaging. They want to focus on things that really matter — family, work, and other commitments — and not have to fuss with the items they buy regularly. And, they will pay a reasonable premium for what functional packaging offers. That represents opportunities for brand owners and the converters who work with them.

Here are our four key takeaways.



1. “All-in-One” is a Winner

Our panelists responded positively to all-in-one packaging that can easily be opened with their hands, then easily resealed (with pressure-sensitive reclosures, snap close lids or other method) for storage. Panelists expressed they don't want to have to take a second step: To use a can opener or other tool, for instance, or to have to transfer unused product to a storage container or baggie.



2. Convenience Matters

Almost all of our panelists spoke about very busy/hectic lifestyles. As such, they were interested in packaging solutions designed for on-the-go use, such as a resealable package of fruit that can be taken out of the fridge, tossed in a gym bag, and opened and closed repeatedly throughout the day (and without messily spilling its contents).

Convenience was also a factor when the panelists discussed storage, though female and male panelists expressed slightly different values. Women said they want packaging that compresses as the supply of product is consumed over time (such as a flexible packaging bag of snack crackers), saving space on a shelf. The men tended to favor packaging that thoroughly protects the product from damage (such as a rigid cracker box).

3. Visual and Audio Cues Signal Freshness

Our panelists widely stated they value freshness. They said packaging can convey freshness on the store shelf, when they get the product home, and for as long as possible in the fridge or pantry. Interestingly, they indicated the freshness “cue” is visual and auditory. Panelists said their confidence depends not only on being able to see how a product's packaging seals, but on being able to hear some sort of confirming sound—a snapping, a whoosh of air, a click—indicating that seal. Investing in increased education and awareness on reclosures may help transform this perception.

4. Ease is for Everyone in the Family

Ease of use emerged as a powerful theme. Once again citing their busy lifestyles, our frequently-multitasking

panelists said they prefer packaging that's easy to open and close, easy to get product out of and back into, and easy to store. This is also an important factor when considering the needs of children (still mastering those motor skills) and the elderly (who may struggle at times with caps, zipper seals, and other closures).

Bonus Insight: Design Matters

Our panelists also expressed they often feel overwhelmed when shopping. They said they not only struggle with the sheer volume of product choices, but commonly find themselves confused by messaging. Multiple panelists stated they didn't realize a product's packaging had functional features; the messaging was simply lost.

So while technology is giving brands the opportunity to differentiate with their packaging, designers need to make sure those features grab consumers' attention on increasingly crowded store shelves. True innovation usually combines breakthrough technology and empathetic design.

Brand owners and converters looking to grow their business with functional packaging should keep these insights in mind. To learn more about this study, contact your Avery Dennison sales representative. **AD**



The Functional Packaging Value Chain

How you Fit, What you Need, Who to Partner With

Now is the time to get into or expand your functional packaging capabilities. Whether for food, beverages or home and personal care, both reclosures and flexible packaging are projected to grow rapidly. Good news for converters in general, but what about your business? Do you have the capabilities, equipment and partner network needed to solicit, win, deliver and benefit from the growth in functional packaging? Let's take a closer look.

The Pressure-Sensitive Reclosure Value Chain

Reclosure uses a combination of flexible packaging material and pressure-sensitive films with a resealable adhesive. Here are the steps involved:

1. Connect with Avery Dennison, the industry leading pressure-sensitive supplier. We'll set you up for success, making sure you're using the correct materials, inks, and varnishes for a seamless transition to the next step.
2. Deliver the printed and die cut labels to an integrator who will move your label onto flexible packaging film.

3. Finally, a contract packager will finish the job, delivering the completed reclosure packages to the brand owner.

If you don't know an integrator you can work with, we can help. We can connect you with our network of proven collaborators and work with you on compliance, making your entry into the reclosure value chain super easy. Our technical experts can also address any concerns you have about product selection or food compliance.

To get started, all a converter needs is a press capable of printing and die cutting film-on-film pressure-sensitive constructions.

The Flexible Packaging Value Chain

Flexible Packaging uses a combination of materials—primarily paper, film and foil—to form pouches with the properties needed to protect the contents. Like reclosure, flexible packaging is primarily a three-step value chain:

1. Connect with a base material supplier like us. Our technical team can help set you up for success, making sure you're using the correct materials, inks, varnishes and laminating adhesives for a seamless transition to the next step.

2. Converters print the film or paper surface and slit rolls to the size of the full pouch for either horizontal or vertical filling.

3. Contract packagers take the printed rolls and process them on form, fill and seal machines, producing the finished pouches.

To get started, converters need:

- A press with tension management controls capable of handling thin, unsupported film
- A corona treater

- Flexible-packaging-compatible UV or water-based inks specific to film and paper
- The ability to laminate (using self-wound PET or press applied adhesive)
- A razor slitter

Market research firm LPC estimates that only 12-15 percent of traditional U.S. label printing companies with annual sales of \$2 million or higher are producing flexible packaging. There are even fewer converters who are currently benefiting from the inclusion of pressure-sensitive reclosure products in their portfolio. **AD**

The Pressure-Sensitive Reclosure Value Chain

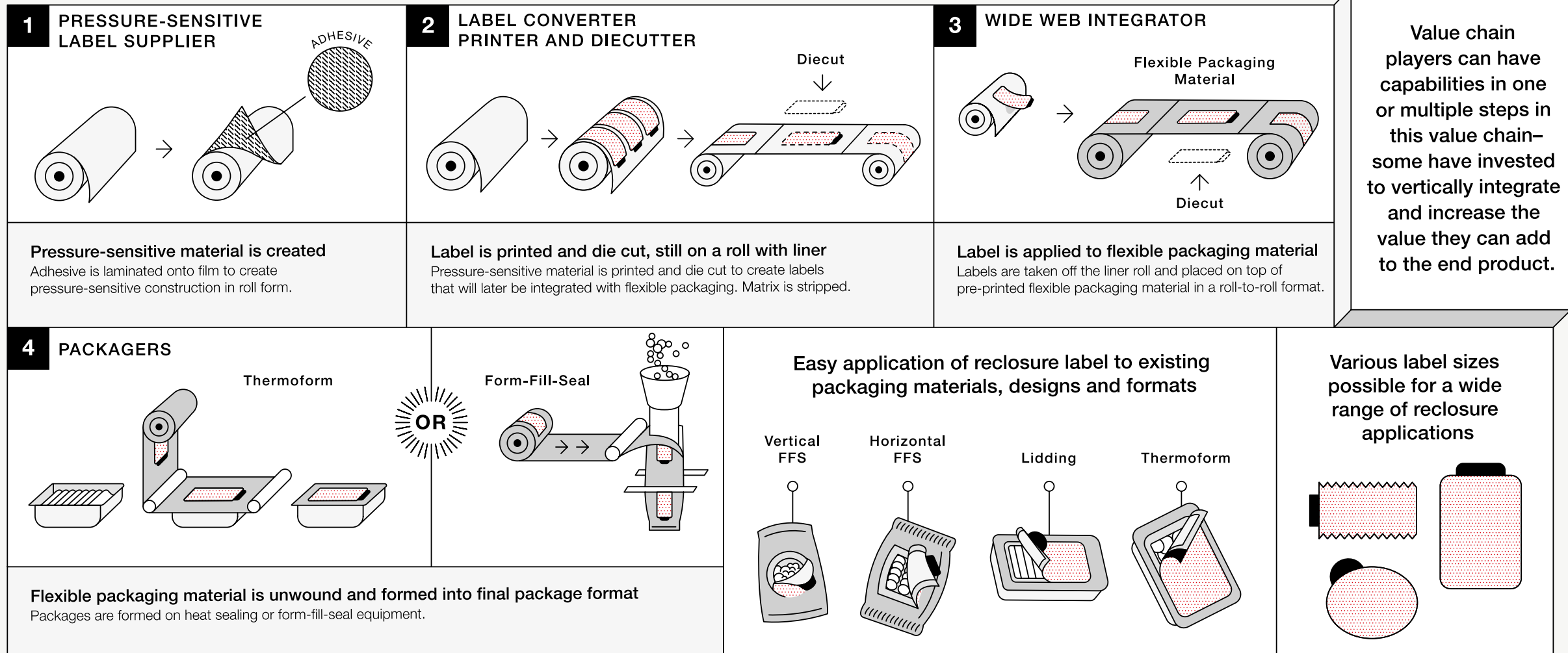

The Flexible Packaging Value Chain

Vertical Form-Fill-Seal

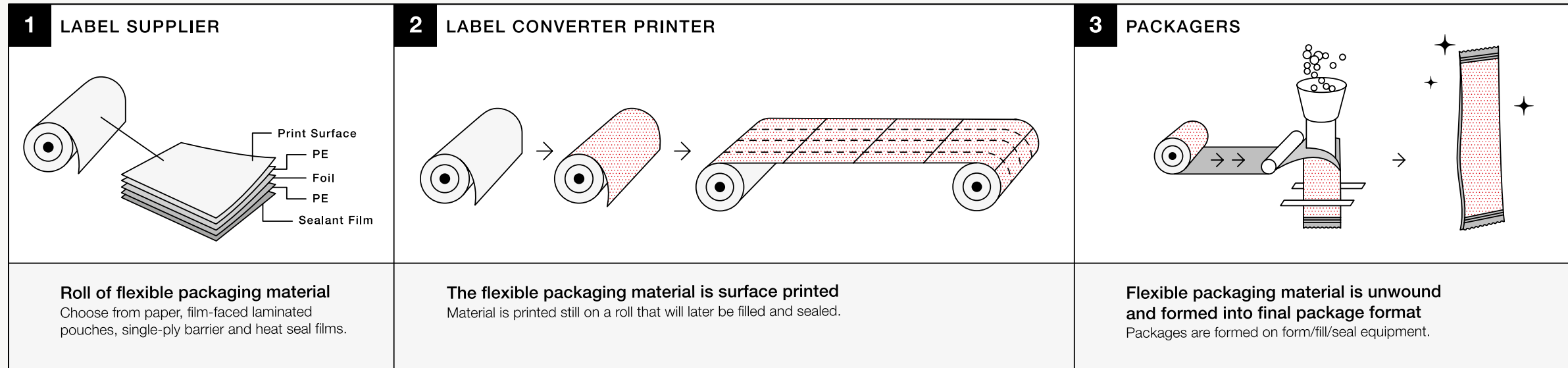

Horizontal Form-Fill-Seal

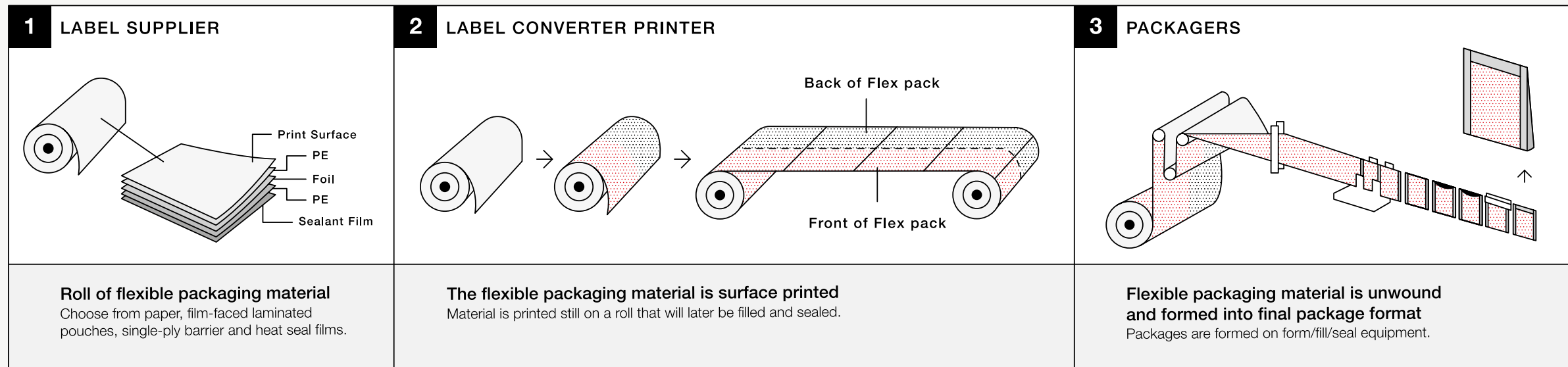



The Intelligent Label Transformation

More industries are poised to increase their use of label constructions enhanced with RFID technology

Don't look now, but the ways we shop, travel, work, play, and stay healthy, are being transformed by Radio Frequency Identification (RFID) technology. According to our internal projections, we expect the RFID market to nearly double in the next four years, from 11 billion units of use in 2018, to 20 billion units in 2021.

RFID inlays can be integrated into virtually any label construction. These "Intelligent Labels" can then be applied to a variety of applications. This transformation truly represents a new world of opportunities for label converters.



Taking a Strategic Approach

Avery Dennison is developing Intelligent Label solutions for use throughout the value chain. These are helping companies improve inventory management, prevent losses, enhance the consumer experience, improve brand perception, and ultimately grow their business.

Yet, our objective is not simply to sell leading products. We also aim to help converters identify, understand, and capitalize on strategic opportunities in the industries and segments they serve.

This means converters can provide appropriate solutions for their entire customer base. They can also lean on Avery Dennison expertise to understand how Intelligent Labeling is being used in specific segments.

Experts Identify Three Segments Poised for Growth with RFID

We reached out to three Avery Dennison RFID market development experts to better understand some of the segments that are poised for growth with this transformative technology.

Aviation

"Aviation first showed interest in RFID for baggage tracking, instead of barcodes, about a decade ago. However the expansion of promising pilot programs was stalled by the 2008 recession. Within the last couple years, Delta has re-kindled use of the technology.

The airline's impressive results are being noticed: Baggage read rates have jumped from less than 95 percent to 99.5 percent. Crews are moving up to 18 percent more baggage through sortation systems. Baggage can be loaded onto aircraft several minutes faster per flight, and with smaller loading crews. Avery Dennison is now working

with the International Air Transport Association (IATA) to promote the technology and drive standardization. We're also looking to help those working with the industry think through the transition from barcode to RFID, including a phase where both technologies will co-exist."

— Mark Summers,
Market Development Manager — Aviation

Beauty

"The market for color cosmetics is growing fast. Sales exceeded 6 billion units in 2016 globally, according to Euromonitor. RFID offers this segment three key advantages. First, it can improve inventory accuracy, for in-store and online fulfillment, in turn to help ensure the customer can get what they're shopping for. Second, RFID can be used for tracking units through the supply chain, into primary retailers and beyond. The technology is expected to be a major weapon in the fight against counterfeiting and diversion. Third, it can help brands create a deeper connection to customers through RFID-enabled point-of-and post-sale experience; it's a powerful tool to help sales associates make product recommendations and upsell."

— Bob Pernice,
Director, Market Development Manager
— Intelligent Labels

Food and Beverage

"Major food suppliers are beginning to use RFID to track returnable shipping trays and crates. We're starting to see some additional uses, mostly at the retail level, prompted by the consumer demand for quality and transparency. For example, stores are using RFID on packages to manage use-by dates, and to limit food waste. They're also using RFID to better manage the flow of

inventory, and to ensure food products are in stock and on shelves when consumers want them. Finally, retailers are beginning to integrate RFID into 'fast checkout' systems. This is being piloted in China, Japan and Europe, and we expect the application to expand globally in coming years."

— Peter Jackson,
Global Market Development Manager
— Food RFID



Be at the Forefront of the Intelligent Label Transformation

As the world's largest UHF RFID partner, Avery Dennison is at the forefront of the Intelligent Label transformation — and this is a great time for label converters to join us. If you're already serving one or more of these segments, or are interested in doing so with RFID, take time to learn about how the technology works, how these brands are using it, and how it benefits consumers.

Rely on your Avery Dennison sales representative as well. He or she is your first point of contact with our Intelligent Label leadership and expertise. **AD**

Technical Leaders

A group of experts is helping converters solve unique challenges large and small.

The Avery Dennison **ADvantage** means you have access to more than just leading products and technology. It means you have access to our people. Our people, in turn, offer expertise, perspective, a deep understanding of the challenges faced by converters, and knowledge of how to turn those challenges into opportunities for growth.

This is the first in a series of AD Teams columns looking at our **ADvantage** technical groups. This quarter, we'll shine a light on our Technical Leaders (TLs), and the Engineered Solutions they offer.

A Diverse Background in Label Conversion

"Being a TL means having a diverse background of technical, process, service and marketing experience," says John Evola, technical solutions director. "You must have a lot of experience in the pressroom to understand business challenges from the

customer's point of view. Of course, you need to know our portfolio and capabilities inside and out. And you need a list of industry contacts that's a mile long."

The Avery Dennison TL team offers this type of diverse background, knowledge, and network. This customer-facing team is also the driving force behind our Engineered Solutions program.

Focused on Answering Customer Challenges

An Avery Dennison Engineered Solution is, by its simplest definition, an answer to a unique customer challenge—a challenge that doesn't appear to be solvable through the customer's routine choice of products or processes.

The answer can take on many forms. TLs can develop an Engineered Solution, for instance, by combining commercially available raw material components to create a custom product. They can mix and match any facestock, adhesive and liner combination, whether from the Avery Dennison portfolio, or available from third-party suppliers. TLs can also vary adhesive and silicone coat weights to fine-tune a product for an application, and create products with patterned adhesives.

TLs have full access to all of our manufacturing assets, including our pilot lines. They can engage our industry partners if there's a need or capability we don't have internally. And, if they still can't find a component to solve a customer's problem, TLs engage



our robust internal R&D team and our global procurement teams to develop a product internally or externally.

Connecting the Dots

"I always stress Engineered Solutions is service, not a product," continues John. "It's something we do. It's a methodology. It's the way a TL approaches a problem. It starts with, and always focuses on, the customer's need—from the small details to the big picture. Then, the TL lines up the most appropriate people and resources, and together that group works to connect the dots back to a solution."

Some Engineered Solutions may take large teams months to conclude. Others may be a quick matter of TL facilitating a contact between a customer and a vendor.

Without "naming names," John listed off a few recent, noteworthy Engineered Solutions.

– A coffee shop chain wanted its sandwich-wrapper label to have a specific look and feel, complementing its use of recycled materials. Our TL brought together internal design resources to create a unique wrapper-label construction for the chain.

– A delicatessen wanted to use direct thermal to print its labels in blue, instead of the standard black. Our TL sourced a paper, that when passing through a direct thermal printing process, images blue.

"In each of these cases, and so many others, it's not just about providing the customer with a product," stressed John. "It's an end-to-end process to solve a challenge for the customer. Our TLs do their best to be on the pressroom floor to look, listen, understand, and advise. Expertise and application knowledge is the core of Engineered Solutions."

– A major auto OEM was having performance issues for labels on one of its plastic oil containers. Our TL coordinated the design of a front/back label that flexes as the container goes through the manufacturer's hot-fill process, solving the issue.

To learn more about our Engineered Solutions capabilities, or to talk through a challenge with one of our TLs, contact your Avery Dennison sales representative. Meet members of the TL team on [page 29](#) of this issue of AD Connect. **AD**



From Left
John Evola, Jacki Wade, and Tony Zalba



ClearIntent™ Portfolio Grows with Responsibly-Sourced Papers

Our ClearIntent™ Portfolio is an ever-growing selection of products that include hundreds of facestocks and adhesives made with fewer inputs, certified and renewable materials, and other performance-enhancing innovations.

Our three pillars include:

- Responsibly source. We offer hundreds of label options made with Forest Stewardship Council® (FSC) certified paper and film made from renewable resources.
- Reduce materials. Thinner labels means consuming fewer resources.
- Recycle. Many ClearIntent products incorporate recycled content or elements that make our customers' products more recyclable.

We are working to expand our ClearIntent Portfolio and have a few highlights to share with you, as we know brand owners are clamoring for more sustainable options.

Expanding the ClearIntent Portfolio

Since the launch of ClearIntent, we've added hundreds of pressure-sensitive products made with FGSC-certified papers and responsibly-sourced films.

These include popular paper options, such as our 54# Semi-gloss, Matte Litho and Maxflex™ Silver papers, as well as DT 200 HD; DT 300 HD; DT200 GP; and Laser 50# DSX papers for variable print applications. We've recently been working on transitioning all of our 60# Semi-gloss papers.

These and other ClearIntent products offer the same or better performance and pricing to our non-sustainable options—so you can provide sustainability while maintaining quality and profitability.

Your Leader for Responsibly-Sourced Paper

Responsible paper sourcing, in particular, is a massive opportunity across our industry.

For Avery Dennison, sourcing is a long-term commitment with a deliberate process and ambitious goals. Strategically, we aim to evaluate and partner with supply-chain partners with good environmental performance, while preferring to use certified/recycled fiber sources.

To underscore our commitment, we're an FSC Chain-of-Custody (COC) certified company.

We're also one of more than 3,500 COC-certified companies in the United States that offer more than 170 FSC-certified products.

At the end of 2016, we made either an FSC or Programme for the Endorsement of Forest (PEFC) claim for 78 percent of total volume of procured paper. Our 2018 North America target is 90 percent certification for all paper, and 80 percent FSC certification for facestock paper. Our 2025 goal is to achieve 100 percent certification for all paper, with 70 percent of facestock carrying the FSC certification.

Promoting Sustainability is Our Responsibility

We're a significant stakeholder in the paper products supply chain. As such, we accept our role as an industry leader, and our opportunity to promote sustainability throughout the value chain. We're driven to work collaboratively across that chain to address the environmental and social impacts of product packaging labeling, retail branding and graphics materials.

Our aim is to improve the sustainability of our products and processes, while helping to create shared value for all of our stakeholders. Our efforts over the last few years have dramatically raised the bar and recently resulted in our ranking #72 on Barron's first list of 100 Most Sustainable Companies.

To learn more about sustainability at Avery Dennison, FSC certification, and to view our ClearIntent portfolio of products, visit label.averydennison.com for videos, case studies and more. **AD**



We offer FSC-certified papers for many of your application needs



Platinum Thermal™ Technology: Combining the best of the DT and TT Worlds



Avery Dennison is adding Platinum Thermal technology to its thermal printing portfolio of products. This breakthrough technology offers a unique combination of printing flexibility and output durability for applications requiring the crispness of thermal printing.

Unique Features, Game-Changing Benefits

Platinum Thermal consists of a surface-printable polyolefin film featuring a black pigment built into the film construction that eliminates the need for thermal transfer ribbons or direct thermal coatings. It's designed for use in most thermal barcode label printers and is compatible with a range of print technologies.

Printed images remain crisp and clear, even with prolonged exposure to heat, cold, light, and water. Based on supplier testing, specific performance features include:

- Temperature resistance—Stable up to 121°C (250° F)
- UV resistance—Images remain crisp, even after as much as 18 months of outdoor exposure

- Chemical resistance—Volatile chemicals evaporate quickly leaving the printed images undisturbed

The combination of benefits—ease, flexibility, and durability—is a game changer. Platinum Thermal can help converters meet brand owner needs across a wide spectrum of applications, including: automotive, food rotation, chemical product packaging, retail/home store/garden center, industrial, inventory management, and test tube labels.

Standard Products Supplemented by Engineered Solutions

Avery Dennison offers Platinum Thermal technology in two constructions; one featuring the AT20 all-temperature adhesive, and another using the S2501 general-purpose adhesive that covers a wide selection of end use applications. The adhesives are combined with a 3 Mil Platinum Thermal Film—and a 40#SCK liner.

The AT20 construction is available through the EXACT™ service program, so rolls can be ordered in a specified

width to eliminate trim and reduce waste. Both constructions are available with next-day shipping, supporting just-in-time inventory management.

If neither construction meets the requirements of a customer's application, Avery Dennison can work with the converter to create one that does. This service is offered through the [Engineered Solutions program](#).

Interested in Platinum Thermal technology? If so, contact your Avery Dennison sales or technical representative. **AD**



A Collection of Ideas from the Avery Dennison Concept Lab



Spec# 77461 Fasson® 2.3M WH TC BOPP/R3500/1.2M PET

Spec# 78632 Fasson® 2.3M WH BOPP TC/R3400/1.2 Mil PET



Spec# 54160 Fasson® 60# Classic® Felt Natural White Wet-Strength FSC®/S100R/44#PK

Spec# 07601 Fasson® Pharmaceutical Cast Gloss +/S246/40#CK





Differentiate and Grow with Unique Label Solutions and Services



Low MOQ



Quick Quote



Fast Delivery

Our list of constructions is vast, with label solutions designed for a multitude of surfaces and applications.

We also offer opportunities to create unique and custom label solutions that can improve performance or productivity, add functionality, enhance shelf appeal, and improve sustainability. Through the Engineered Solutions program and the **ADvantage: Technical Excellence Team**, we offer personal support on ideation through prototype, testing and production for new solutions.

An end-to-end process that focuses on a converter's specific challenge, the final

output of an Engineered Solution might range from a unique facestock, adhesive, liner or prototype created in our Innovation Center; to a new combination of standard offerings; to a product available from our suppliers, but not currently in our portfolio; to anything and everything in between.

Services that Help Eliminate Waste and Improve Efficiency

Whether for an Engineered Solution, or an off-the-shelf label construction, our service programs can help converters streamline their operations and reduce waste.

The Avery Dennison Fasson® EXACT™ service program offers converter-specified roll widths for multiple fixed

lengths, matching required slit patterns. EXACT helps eliminate end-wasted roll remainders and offcuts, and gives converters press-ready rolls to further increase their operational efficiency.

The Ready Width™ program offers low-volume products at standard widths and lengths not currently in the EXACT program. It's an alternative to buying full master rolls, and one more way to eliminate waste.

We also offer rapid pricing, low minimum order quantities (MOQ), and samples for testing. Contact your Avery Dennison sales representative for more information about these services.

Success in three steps:

1. Choose from Application-specific Portfolios
Avery Dennison Select Solutions™ Collection portfolios offer unique label solutions that can improve performance or productivity, add functionality, enhance shelf appeal or improve sustainability.

2. Leverage our Engineered Solutions Program
Engineered Solutions is a service that focuses on a converter's specific needs, and can create custom products that differentiate your business and grow your bottom line.

3. Tap into the Avery Dennison ADvantage
Our Avery Dennison **ADvantage: Technical Excellence Team** is always eager to help you find the most suitable product to meet your labeling needs in terms of performance, compliance, and shelf appeal.

The Avery Dennison **ADvantage:** Technical Leaders

The Avery Dennison Technical Leaders bring together a diverse background of technical, process, service and marketing know-how, supplemented by deep pressroom experience and a broad network of trusted industry contacts. They are here to help you solve problems from the basics to one-of-a-kind Engineered Solutions.



John Evola

John has 25 years of label and packaging materials experience. With a diverse background including roles in research and development, sales, and technical consulting, he is able to quickly present viable solutions and is the director of the team.



Ray Mackura

Ray has experienced many facets of the label and packaging materials industry during his more than 30-year career. Currently, he assists clients in identifying growth opportunities using custom materials.



Shane Bendelewski

With nearly 10 years of label and packaging materials experience, Shane is responsible for growth in specialty product segments through new, application-specific product development, utilizing new and existing raw materials, processes and technologies.



Pete von Kleist

Pete has 42 years of experience in the label and packaging industry. During this time, he has held positions in quality, research and development, and custom product development, with a specialization in the wine and spirits segment.



Rick Bertone

Rick has more than 15 years of label and packaging industry experience. In his current role, he designs, recommends, and oversees the manufacturing of custom solutions for his clients' specialty needs.



Jacki Wade

Jacki has nearly 20 years of label and packaging materials experience. She specializes in the development of innovative solutions for clients, and offers extensive knowledge of the durable goods segment.



Jana Braun

With more than 16 years of label and packaging materials experience, Jana assists her clients in navigating the specialty arena, including working to engineer custom products for specialty applications.



Tony Zalba

Tony has been helping converters and brand owners identify label and packaging solutions for more than 20 years. He takes great pride in helping his clients solve challenging applications with custom designed products.

Select Solutions™ Apparel Portfolio

Thermal transfer printable options for sizing strips and other pressure-sensitive graphic apparel applications

Applications

Apparel
Jeans, pants, sportswear, menswear, women's apparel, children's wear, socks, shoes, sweaters and more

Textiles
Blankets and bedding



Portfolio Characteristics

- A range of clear, white and natural-looking materials
- Brown and white liner materials in various weights and thicknesses
- Adhesives specifically designed for application to and easy removal from fabrics without residue

	R5195	R120	S4900	S4600	S692N	AT20
Adhesive Technology	Emulsion Acrylic	Emulsion Acrylic	Emulsion Acrylic	Emulsion Acrylic	Emulsion Acrylic	Emulsion Acrylic
Service Temp Range	-65 to 185	-40 to 200	-40 to 200	-40 to 300	-20 to 200	-65 to 200
Minimum application temperature	40	50	25	10	23	-20
Cotton	Recommended	Recommended	Recommended	Recommended	Recommended	Recommended
Denim	Recommended	Not Recommended	Recommended	Recommended	Recommended	Recommended
Stretch Denim	Recommended	Not Recommended	Recommended	Recommended	Recommended	Not Recommended
Polyester	Recommended	Recommended	Not Recommended	Not Recommended	Recommended	Recommended
Rayon	Recommended	Recommended	Recommended	Not Recommended	Recommended	Recommended
Nylon/Spandex	Not Recommended	Not Recommended	Recommended	Recommended	Not Recommended	Recommended

■ Recommended - Test in actual application ■ Not Recommended
■ Recommended - Lower peel

*Testing is recommended for all applications as there may be variation between colors, weaves and fabric blends
 NOTE: We do not recommend applying pressure-sensitive labels to satin, silk, suede, leather, felt, velour, corduroy or velvet materials. Adhesive testing is suggested for specific applications.

Spec#	Product Description	Width/Length (In./Ft.)	Location	Lead Time
18559	60# Archival SG/R5195/40#LF	RW 13/10000	FTW	Next Day
79711	TransCode® White/R120/50#BRN	60/4167	PVL	5 Days
79712	TransCode® White II/R120/50#SCK	54/2500	PVL	4 Days
79713	TransCode® Clear/R120/50#BRN	60/1668	PVL	Next Day
79714	TransCode® + Clear/R120/50#BRN	60/2500	PVL	4 Days
74523	2 Mil Clear BOPP 7525/S4900/40#SCK	EXACT™/5000	PVL	Next Day
75617	TransCode®+ White/S4900/50#BRN	EXACT™/7500	PVL	Next Day
74087	TransCode® White II/S4900/50#	60/2500	PVL	Next Day
75616	TransCode®+ Clear/S4900/50#BRN	EXACT™/7500	PVL	Next Day
74106	TransCode® Clear II/S4600/50#BRN	60/1668	PVL	5 Days
75233	TransCode® White/S4600/50#BRN	60/4200	PVL	7 Days
79576	TransCode® + White/S692N/50#BRN	60/2500	PVL	4 Days
79575	TransCode® + Clear/S692N/50#BRN	60/2500	PVL	4 Days
79578	TransCode® + White/AT20/50#BRN	60/2500	PVL	4 Days
79577	TransCode® + Clear/AT20/50#BRN	60/2500	PVL	4 Days

FTW=Fort Wayne, IN PVL=Painesville, OH

Select Solutions™ Appliance Portfolio

Functional constructions developed to perform on a variety of difficult-to-adhere-to surfaces

Applications

Washers and dryers
Refrigerators
Microwaves
Coffee makers
Televisions
Toasters/toaster ovens
Trash compactors

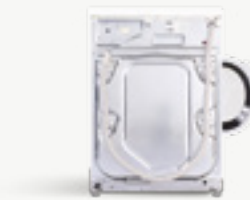

Portfolio Characteristics

- Advanced adhesives that perform on difficult-to-adhere-to surfaces that are heavily textured; feature brushed metal, powder coatings and velvet finishes; or have come in contact with chemical cleaning agents
- Materials that offer branding and point-of-purchase performance, while providing abrasion, tear, and moisture and environmental resistance
- Voidable film facestocks and tamper-evident vinyls designed for counterfeiting and security functionality
- Removable adhesives for quick, clean removal
- Constructions suited for laser and thermal transfer printing

Spec#	Product Description	Width/Length (In./Ft.)	Location	Lead Time
78385*	2 Mil White PET TC/S8001/50#SCK	EXACT™/5000	NEE	1 Day
78387*	2 Mil Chrome PET TC/S8001/50#SCK	EXACT™/5000	NEE	1 Day
		EXACT™/2500	PVL	1 Day
77844*	1 Mil Clear PET Overlamine	EXACT™/5000	PVL	1 Day
		EXACT™/2500	WCT	1 Day
78401*	3 Mil Synthetic Paper/S8001/50#SCK	EXACT™/5000	PVL	1 Day
78403*	2.3 Mil White BOPP TC/S8001/50#SCK	EXACT™/5000	NEE	1 Day
78947*	2 Mil Clear PET TCRC/S8015LW/50#MF	Stock 6/2500	PVL	1 Day
79327*	2 Mil Clear PET TCRC/S8025/50#MF	Custom Coat 60	PVL	7-10 Days
77921*	2 Mil Clear PET TC/S8025/50#SCK	EXACT™/5000	NEE	1 Day
78064**	2.3 Mil White BOPP TC/I406KB/40#BG	Custom Coat 60	PVL	7-10 Days
79648*	4 Mil Vinyl TCD/S8025/50#SCK	Stock 54/16 68	PVL	1 Day
18328	60# Semi-Gloss Elite™/R5195/40#SCK	EXACT™/5000	FTW, PTC, QTN, DAL, WCT	1 Day
		EXACT™/10000	FTW, QTN	1 Day
78149	2.3 Mil White BOPP TC/R3500/40#SCK	EXACT™/5000	PVL	1 Day
78826	2 Mil Clear BOPP TC/R1490/1.2 Mil PET	Stock 54/1668	NEE	1 Day

*UL®-recognized

**UL-recognition pending

NEE=Neenah, WI PVL=Painesville, OH WCT=West Coast FTW=Fort Wayne, IN

PTC=Peachtree City, GA QTN=Quakertown, PA DAL=Dallas, TX

Select Solutions™ Automotive Portfolio

Performance that goes the distance

Portfolio Characteristics

- Full range of self-adhesive materials, including multiple facestocks and adhesives
- High temperature and chemical resistance
- Durable performance in harsh environments
- Compliant with REACH, RoHS, IMDS and common testing parameters specified by automotive OEMs
- Excellent adhesion to a wide range of substrates, including rough and low surface energy plastics

Applications

Under-the-hood

Labels for heat/chemical-resistant warnings, engine component instructions, tracking, fluid containers, car batteries and cables

Exterior

Fuel cap, tire pressure and tracking/service labels

Interior

Airbag, security/anti-counterfeit, warning, instruction and tracking labels



Spec#	Product Description	Width/ Length (In./Ft.)	Location	Lead Time	Metal Substrates	Painted and Plastic Substrates	Rough/Low Surface Energy Substrates	Interior Use Only
76656	2 Mil White PET TC/S8015/50#SCK	Stock/5000 EXACT™/1668	NEE	1 Day	✓	✓		
76658	2 Mil Matte White PET TC/S8015/50#SCK	Custom Coat/5000	PVL	5 Days	✓	✓		
76660	2 Mil Matte Chrome PET TC/S8015/50#SCK	EXACT™/1668	NEE	1 Day	✓	✓		
*79453	2 Mil White PET TC/S8049/50#SCK ABC	Stock/1668	PVL	1 Day	✓	✓	✓	
79534	2 Mil Matte Chrome PET TC/S8049/50#SCKABC	Custom Coat/1668	PVL	5 Days	✓	✓	✓	
78385	2 Mil White PET TC/S8001/50#SCK	EXACT™/5000	PVL	1 Day	✓			✓
78401	3 Mil Synthetic Paper/S8001/50#SCK	EXACT™/5000	PVL	1 Day	✓			✓
78387	2 Mil Matte Chrome PET/S8001/50#SCK	EXACT™/5000	NEE	1 Day	✓			✓
79653	2 Mil White PET TC/8049A/EZ Liner	Custom Coat/1000	PVL	4 Days	✓	✓	✓	
79654	2 Mil Brushed Chrome PET TC/8049A/EZ Liner	Custom Coat/1000	PVL	4 Days	✓	✓	✓	
*79732	2 Mil White PET TC/S8029/50# SCK ABC	Single Roll/2500 Stock/1668	PVL	4 Days 1 Day	✓	✓	✓	✓
Overlaminates								
77855	1 Mil Clear Print-Treated PET/S730/1 Mil PET	EXACT™/5000	NEE	1 Day				
77841	1 Mil Clear PET TC/S8020/40# BG	Ready Width™ 6/5000 Ready Width™ 12/5000	PVL	1 Day				
Products designed to be tamper evident								
78194	2 Mil White Void PET TC/S8015W/50#SCK	EXACT™/1700	NEE	1 Day	✓	✓		
78195	2 Mil Silver Void PET TC/S8015/50#SCK	EXACT™/1700	NEE	1 Day	✓	✓		
Labels designed to adhere to silicone or silicone-treated surfaces								
*79438	1.5 Mil White PET TC/S8092/3 Mil PET	Single Roll/850	PVL	1 Day				

PVL=Painesville, OH NEE=Neenah, WI

*Single Slit Roll Service Program: Available in any width by 2500 ft. (3 in. core)

✓ = Performs on designated substrates

Select Solutions™ Candle and Soap Portfolio

Withstands chemicals and wax exposure on candles, candle wrappers and jars, and soaps

Portfolio Characteristics

- Best-in-class adhesive works beautifully on waxy surfaces; provides long-lasting, reliable adhesion even if substrate is porous
- Materials withstand continued exposure to chemicals and fluctuating temperatures
- Top coated option for HP Indigo digital press printing
- Adapt well to specialty printing techniques like foil and hot stamping, embossing and silk screening

Applications

- Candles
- Candle wrappers and packaging
- Candle jars
- Soaps and soap packages



Spec#	Product Description	Width/Length (In./Ft.)	Location	Lead Time
77410	2 Mil Metallized BOPP TC/S2300/1.5 Mil PET	54/1000	PVL	4 Days
78363	1.5 Mil Clear Print-Treated PET/S2300/1.5 Mil PET	54/1000	PVL	4 Days
78382	2 Mil White Print-Treated PET/S2300/1.5 Mil PET	54/1000	PVL	4 Days
79350	2.6 Mil White BOPP TC/S2300/1.5 Mil PET	54/1000	PVL	4 Days
79360	2.6 Mil White BOPP ITC/S2300/1.5 Mil PET	13/2500	FTW	7 Days

PVL=Painesville, OH FTW=Fort Wayne, IN

Select Solutions™ Bumper Sticker Portfolio

Durable constructions that get noticed

Portfolio Characteristics

- Consistent adherence to a range of substrates
- Weather- and temperature-resistant
- A range of cost and performance options
- Excellent dimensional stability
- Materials with a variety of processes from flexo to digital
- Ready-to-roll, lay-flat liner suited for sheet applications
- Topcoated and non-topcoated materials

Applications

- Automotives and fleet
- Promotional materials



Spec#	Product Description	Width/Length (In./Ft.)	Location	Lead Time
78244	Bmpstk 4 Mil Vinyl NTC/S475/78#CCK	54/2500	PVL	4 Days
86272	4 Mil White Flex Vinyl/S475/65#MF	54/2500	PVL	4 Days
41168	4 Mil White Flex Vinyl/R143/50#	54/2500	PVL	10 Days

PVL = Painesville, OH

Select Solutions™ Natural Kraft Paper Portfolio

A kraft paper facestock, matched with a range of purpose-built adhesives, provides a premium, natural look for multiple applications

Portfolio Characteristics

- Five adhesives of varying strengths
- Unbleached, uncoated kraft brown paper facestock
- 40# SCK liner
- 44# poly coated kraft liner option

Applications

- Spirits
- Industrial



Spec#	Product Description	Width/Length (In./Ft.)	Location	Lead Time
53470	Natural Label/SOX2/40#SCK TNR	78/1668	FTW	Next Day
04786	Natural Label/S246/40#SCK	30/1500	PTC	4 Days
16328	Natural Label/AT20/40#SCK	60/1668	PVL	Next Day
15788	Natural Label/S100R/44#PK	60/2500	PVL	5 Days
19725	Natural Label/HMR/40#SCK	60/1500	PTC	4 Days

FTW= Fort Wayne, IN PTC=Peachtree City, GA PVL=Painesville, OH

Select Solutions™ Cover-up Portfolio

High-opacity barrier coating on paper or film corrects errors and covers-up outdated information on packaging, labels and containers

Portfolio Characteristics

- Durable, pressure-sensitive films, coated and uncoated papers
- A range of adhesives
- More cost-effective and convenient than removing old labels or replacing entire packages
- Easily masks obsolete variable information, barcodes and pricing
- New data is easy to read and completely scannable

Applications

Logistics and transport
Pharmaceutical
Industrial chemical labeling
Food and retail promotions
Home and personal care



Spec#	Product Description	Width/Length (In./Ft.)	Location	Lead Time
15477	Semi-Gloss Elite™ FasCover™ 2/AT20/40#SCK	EXACT™/2500	WCT	Next Day
		EXACT™/5000	FTW	
19185	54# Semi-Gloss FasCover™ 2/C2500/40#SCK	EXACT™/5000	PTC	Next Day
07636	60# Cast Gloss FasCover™ 2/AT20/40#SCK	EXACT™/5000	FTW	Next Day
06263	Matte Litho FasCover™ 2/AT20/40#SCK	78/1668	FTW	Next Day
13601	Trans-Therm® 1C FasCover™ 2/AT20/40#CK	EXACT™/5000	FTW	Next Day
15562	Direct-Therm 200HD FasCover™/AT20/40#SCK	60/1668	PVL	Next Day
53825	Inverted-Face MaxFlex™ Bright Silver/S246/40#SCK	30/1500	PTC	4 Days
08192	Inverted-Face Bright Silver Foil/S246/40#SCK	30/1500	PTC	4 Days
75312	Inverted-Face Metallized Primax® 250/S1000/44#PK	Single Roll*/2500	PVL	4 Days

PVL=Painesville, OH PTC=Peachtree City, GA FTW=Fort Wayne, IN WCT=West Coast
Single Slit Roll Service Program: Available in any width by 2500 ft. (3 in. core)

Select Solutions™ Piggyback Portfolio

Dynamic and versatile, multi-layer constructions featuring one self-adhesive label on top of another

Portfolio Characteristics

- Available in a wide variety of materials and adhesives, including removables
- Film piggybacks offer weather resistance and conformability
- Image liner piggybacks provide a carbon copy label that can be affixed to another surface
- Single customer development available

Applications

Inventory management
Promotional labels
Work-in-process labels



Spec#	Product Description	Width/Length (In./Ft.)	Loc.	Lead Time
74796	Fasson® 2.5 Mil Matte Clear Valtuff®/S3000/3 Mil Clear Polyester/S3000/44#PK	54/2500	PVL	5 Days
78428	Fasson® 3 Mil Matte White Synthetic Paper/S4600/1.2 Mil Polyester/S4600/50#SCK	54/2500	PVL	5 Days
79436	2 Mil CL BOPP PB/S692N/1.5 PET/S692N/50#SCK	60/2500	PVL	5 Days
78253	Fasson® PRIMAX® 250/S1000/1.5 Mil Polyester/S1000/40#SCK	60/2500	PVL	5 Days
13373	Fasson® 50# DSX™ PB/S2501/40#SCK/S2501/50#SCK	Ready Width™ 6.5/10000	FTW	Next Day
		Ready Width™ 9.25/10000		
16120	Fasson® Trans-Therm® 1C/S2501/40#SCK/40#SCK	78/1668	FTW WCT	Next Day
		EXACT™/5000	FTW	
		78/1668	FTW	
15485	Fasson® 60# Semi-Gloss Elite™/S2501/40#SCK/S2501/40#SCK	Ready Width™ 6/5000	FTW	Next Day
		Ready Width™ 9.75/5000	FTW	
		Ready Width™ 13/5000	FTW	
14814	Fasson® Trans-Therm® 1C/S246/40#SCK/S246/40#SCK	60/1668	WCT	Next Day
05252	Fasson® Trans-Therm® 1C /AT20/40#SCK/AT20/40#SCK	60/2500	PVL	5 Days
		78/1668	FTW	
15484	Fasson® 60# Semi-Gloss Elite™/S2501/40#SCK/S2501/50#SCK	Ready Width™ 6.5/5000	FTW	Next Day
15219	Fasson® Direct-Therm 300HD/AT20/40#SCK/40#SCK	60/4167	PVL	5 Days
17574	Fasson® 50#DSX/AT20/Image Liner/AT20/50#SCK	60/2500	PVL	5 Days

PVL=Painesville, OH WCT=West Coast FTW=Fort Wayne, IN
Single Slit Roll Service Program: Available in any width by 2500 ft. (3 in. core)

Select Solutions™ Drum Portfolio

Durable, proven materials featuring BS 5609 Section 2 and 3 certification

Portfolio Characteristics

- Consistent adherence to a range of drum surfaces
- Strong enough to withstand ongoing outdoor exposure
- Weather- and temperature-resistant
- Impervious to contact with aggressive chemicals and saltwater
- Highly adaptable to varying container sizes and diameters
- A range of cost and performance options
- Materials suitable for thermal transfer and laser printing
- Repositionable adhesives

Applications

- Containers
- Drums



Spec#	Product Description	Width/Length (In./Ft.)	Location	Lead Time
Print Method: Laser				
78037	3.4 Mil Lasercode DL TC/S4600/79#CCK BS 5609 Section 2 Yes BS 5609 Section 3 Lexmark C792E, Primera CX1200, NeuraLabel 500e	EXACT™/5000	PVL	Next Day
54162	2 Mil White Laser PET/S4600/66#PK BS 5609 Section 2 Yes BS 5609 Section 3 Lexmark C792E	Stock/1668	PVL	Next Day
Print Method: Thermal Transfer & UV Inkjet				
79572	3.7 Mil Smudgeproof Kimdura®/S4600/50#SCK BS 5609 Section 2 Yes BS 5609 Section 3 Cab: ITW B324 Black +B324 Red Resin, ITW B128 Black+B120 Red, Zebra: ITW B128 Black+B120 Red, Zebra: limak SP330 Black+DC300 Ruby Red, Zebra: Armor AXR 8 Black+AXR600R Red, Zebra: ITW B324 Black +B324 Red Resin, Zebra: ITW CP TR5940 Black+TR5440 Red, Datamax: Armor AXR 8 Black+AXR600R Red, Datamax: ITW B324 Black +B324 Red Resin, Datamax: ITW CP TR5940 Black+TR5440 Red, Microplex: AXR7/600, Jetrion: 4000 Series for 4900 Press, Jetrion: 4950, DNP TRX-50 Black, Durst Tau330 Black	EXACT™/1000	PVL/ FTW/ WCT	Next Day

Spec#	Product Description	Width/Length (In./Ft.)	Location	Lead Time
Print Method: Thermal Transfer & UV Inkjet				
72197	Fasson® 4 Mil TransCode®/S475/50#SCK BS 5609 Section 2 Yes BS 5609 Section 3 Zebra: DNP R300 Black+R510 Red, Zebra: ITW B128 Black+B120 Red, Zebra: limak SP330 Black+DC300 Ruby Red, Zebra: Armor AXR 8 Black+AXR600R Red, Zebra: limak SP575 Black+DC300 Ruby Red, Zebra: ITW B324 Black+B324 Red Resin, Zebra: ITW CP TR5940 Black+CP TR5440 Red, Zebra: Astromed RY Black+RAE Red, Datamax: DNP R300 Black+R510 Red, Data: limak SP330 Black+DC300 Ruby Red, Datamax: Armor AXR 8 Black+AXR600R Red, Data: limak SP575 Black+DC300 Ruby Red, Datamax: ITW B324 Black +B324 Red Resin, Datamax: ITW CP TR5940 Black+CP TR5440 Red, Durst Tau330, Jetrion: 4000 Series for 4900 Press, Jetrion: 4950, Mark Andy Digital One	EXACT™/5000	NEE/ WCT	Next Day
79480	2.6 Mil Synthetic Paper/8020/50#SCK BS 5609 Section 2 Yes BS 5609 Section 3 Zebra: ITW B324 Black +B324 Red Resin, Zebra: DNP, R300 Black+R510 Red, Zebra: ITW B128 Black+B120 Red, Zebra: Armor AXR 8, Black+AXR600R Red, Datamax: ITW B324 Black +B324 Red Resin, Datamax: Armor AXR 8 Black+AXR600R Red, Jetrion: 4000 Series for 4900 Press	Stock/1000	PVL	Next Day
Print Method: Inkjet				
79348	Fasson® 5 Mil Matte Inkjet DL Kimdura®/S4600/50#SCK BS 5609 Section 2 Yes BS 5609 Section 3 Epson C831, TMC3400, TMC3500, NeuraLabel 300x	EXACT™/2500	PVL	Next Day
Print Method: Flexo				
79572	3.7 Mil Smudgeproof Kimdura®/S4600/50#SCK BS 5609 Section 2 Yes BS 5609 Section 3 Flint corona treatment: Flint Force (all colors) - No Varnish, Flint Force (all colors) - Varnish (Flint UVF 02052) Environmental Ink (corona treated): DR III FR Ink (all colors) - No Varnish, Films III Ink (all colors) - No Varnish, Wikoff: PolyTech XR (all colors) - No Varnish	EXACT™/1000	PVL/ FTW/ WCT	Next Day
72197	Fasson® 4 Mil TransCode®/S475/50#SCK BS 5609 Section 2 Yes BS 5609 Section 3 Flint no corona treatment: Flint Force (all colors) - Non Varnish, Flint Force (all colors) - Varnish (Flint UVF 02052) Environmental Ink (corona treated): DR III FR Ink (all colors) - No Varnish, Films III Ink (all colors) - No Varnish Actega: Optifilm Ink (all colors) - Varnish (Flint UVF 02052), Versifilm Ink (all colors) - Varnish (UVF 02052) Wikoff: PolyTech XR (all colors) - No Varnish	EXACT™/5000	NEE/ WCT	Next Day
79480	2.6 Mil Synthetic Paper/8020/50#SCK BS 5609 Section 2 Yes BS 5609 Section 3 Flint no corona treatment: Flint Hydrofilm Ace (all colors)- Varnish (Flint UVF 02052) Environmental Ink (corona treated): DR III FR Ink (all colors) - No Varnish, Films III ink (all colors) - No Varnish, Wikoff: PolyTech XR (all colors) - No Varnish	Stock/1000	PVL	Next Day

PVL=Painesville, OH WCT=West Coast
NEE=Neenah, WI FTW=Fort Wayne, IN

Select Solutions™ Fas-Flex™ Plate Mounting Tapes

Simple, easy and direct for Narrow Web Flexographic Printing

Applications

Flexographic presses



Portfolio Characteristics

- Excellent image quality for print designs from solids to fine lines and screens
- Easy to reposition during the mounting process
- Removes cleanly from both plates and cylinders with little to no adhesive residue
- Consistent tolerance and dimensional stability helps to reduce uncontrolled dot gain
- Allows for minimal vibration, gear chatter and bouncing at high press speeds

Spec#	Product Description	Width/Length (In./Ft.)	Location	Lead Time
57708	Fas-Flex™ 8615S	Slit to width/75	PVL	2 Days*
57709	Fas-Flex™ 8615M	Slit to width/75	PVL	2 Days*
57710	Fas-Flex™ 8615H	Slit to width/75	PVL	2 Days*

*Order Note: All orders placed by 3:00 P.M. EST will ship within 48 hours. All orders ship UPS 2 Day. PVL=Painesville, OH

Select Solutions™ Fire Extinguisher Portfolio

New UL® 299 recognized solutions

Applications

Fire extinguishers
Safety equipment



Portfolio Characteristics

- Two solutions with UL recognized inks, ribbons and adhesives for labeling portable dry chemical and powder fire extinguishers (Class D), and stainless steel water-based units (Class A)
- UL recognized label system allows you to file for a label adoption, significantly reducing the time, cost and effort of adding a product to a UL file

Spec#	Product Description	Width/Length (In./Ft.)	Location	Lead Time
77536	2.3 Mil White BOPP/S6600/50#SCK	EXACT™/5000	PVL	Next Day
77844	1 Mil Clear Print-Treated Polyester/S8020/40#BG	EXACT™/2500	PVL, WCT	Next Day
		EXACT™/5000	PVL	

PVL=Painesville, OH WCT=West Coast

Select Solutions™ Food Safety and Promotion Portfolio

Fluorescents and dissolvables identify and safeguard

Applications

Dissolvable
Inventory labels
Container date code labels

Fluorescents
Promotional labels
Warning labels



Portfolio Characteristics

- Food rotation labels help ensure compliance with FDA regulations
- Dissolvables disintegrate in water in seconds with slight agitation
- Dissolvable labels are an excellent solution for food rotation or inventory management to help drive productivity
- Fluorescents are available in many bold colors

Spec#	Product Description	Width/Length (In./Ft.)	Location	Lead Time
15666	Dissolvable PPR SC/S2600/40#SCK	45/1668	PVL	Next Day
		Ready Width™ 15.5/5000	DAL	Next Day
		Ready Width™ 13/5000	DAL	Next Day
		Ready Width™ 9/5000	DAL	Next Day
00940	ReDeem-a-LBL/S246/40#SCK	30/1500	PTC	4 Days
15284	Chart Fluor/C2500/40#SCK	EXACT™/5000	PTC	Next Day
15283	Green Fluor/C2500/40#CK	EXACT™/5000	PTC	Next Day
15282	Orange Fluor/C2500/40#CK	EXACT™/5000	FTW, PTC	Next Day
15285	Pink Fluor/C2500/40#SCK	EXACT™/2500	PTC	Next Day
		60/1668	TOR	Next Day
15281	Red Fluor/C2500/40#CK	EXACT™/5000	FTW, WCT, PTC	Next Day
03222	Green Fluor/S246/40#SCK	30/1500	PTC	4 Days
02923	Orange Fluor/S246/40#SCK	30/1500	PTC	4 Days
03224	Pink Fluor/S246/40#SCK	30/1500	PTC	4 Days
03145	Red Fluor/S246/40#SCK	30/1500	PTC	4 Days
08923	Chart Fluor/R195/40#SCK	60/1000	PVL	Next Day
07933	Green Fluor/R195/40#SCK	60/4200	PVL	4 Days
07932	Orange Fluor/R195/40#SCK	60/1668	PVL	Next Day
08922	Pink Fluor/R195/40#SCK	60/1000	PVL	Next Day
03929	Chart Fluor/R128/40#SCK	30/1500	PTC	4 Days
02822	Green Fluor/R128/40#SCK	30/1500	PTC	4 Days
02536	Orange Fluor/R128/40#SCK	30/1500	PTC	4 Days
02665	Red Fluor/R128/40#SCK	30/1500	PTC	4 Days
53530	Bright Silver Foil C2510/50#SCK	30/1500	PTC	4 Days
53528	Dull Silver Foil/C2510/50#SCK	30/1500	PTC	4 Days

DAL=Dallas, TX FTW= Fort Wayne, IN PVL=Painesville, OH PTC=Peachtree City, GA WCT = West Coast TOR=Toronto, ON, Canada

Select Solutions™ Holographic Portfolio

Light and reflection bring brands to life

Portfolio Characteristics

- Thin and flexible
- Excellent dimensional stability
- Diffracts normal white light into brilliant color
- Micro-embossable with images or patterns
- Seamless holographic rainbow

Applications

- Standout labels
- Home and personal care
- Security labels
- Wine and spirits
- Flexible packaging
- Food



	Spec#	Product Description	Width/Length (In./Ft.)	Location	Lead Time
Holographic Films	78976	2 Mil Powder PET/S692N/50#SCK	39/1000	PVL	4 Days
	78973	2 Mil Sparkles PET/S692N/50#SCK	39/1000	PVL	4 Days
	78971	2 Mil Crystals PET/S692N/50#SCK	39/1000	PVL	4 Days
	79016	2 Mil Rainbow OPP/S692N/40#SCK	EXACT™/5000	PVL	Next Day
	79072	2 Mil Crystal OPP/S692N/40#BG	54/1000	PVL	4 Days
	79079	2 Mil Rainbow ITC/S692N/50#SCK	13/5000	FTW	7 Days
	79579	2 Mil Rainbow Seamless PET/S692N/50#SCK	30/2500	PVL	4 Days
	Holographic Papers	02391	Fasson® FasPrism™ Iridesc/S246/40#SCK	EXACT™/5000	PTC
08753		Fasson® FasPrism™ Shear/S246/40#SC	30/1500	PTC	4 Days
10938		Fasson® FasPrism™ Ice/S246/40#SCK	30/1500	PTC	4 Days
12071		Fasson® FasPrism™ Glitter + II/S246/40#SCK	30/1500	PTC	4 Days
53786		Fasson® FasPrism™ Rainbow Seamless/S246/40#SCK	30/1500	PTC	4 Days
13645		Fasson® FasPrism™ Iridesc/R128/40#SCK	30/1500	PTC	4 Days
19437		Fasson® Inverted-Face FasPrism™/S246/44#PK	30/1500	PTC	4 Days

FTW= Fort Wayne, IN PVL=Painesville, OH PTC=Peachtree City, GA
Single Slit Roll Service Program: Available in any width by 2500 ft. (3 in. core)

Select Solutions™ HVAC Portfolio

Materials designed to perform on a broad range of surfaces under intense conditions

Portfolio Characteristics

- Materials that showcase branding and point-of-purchase; with adhesives that remove cleanly over time
- Excellent abrasion and tear resistance; moisture resistance; environmental resistance (temperature extremes / UV / chemicals)
- Advanced adhesives for difficult-to-adhere-to surfaces
- Compatibility with oily surfaces
- Compatibility with laser, thermal transfer, inkjet and conventional printing methods

Applications

- Air conditioners/air handlers
- Furnaces
- Water heaters
- Heat pumps
- Radiant flooring
- Thermostats
- Dehumidifiers
- Ventilation



Spec#	Product Description	Width/Length (In./Ft.)	Location	Lead Time
78385*	2 Mil White PET TC/S8001/50#SCK	EXACT™/5000	NEE	Next Day
78387*	2 Mil Chrome PET TC/S8001/50#SCK	EXACT™/5000	NEE	Next Day
		EXACT™/2500	PVL, WCT	Next Day
77844*	1 Mil Clear PET Overlam	EXACT™/2500	WCT	Next Day
		EXACT™/5000	PVL	Next Day
78401*	3 Mil Synthetic Paper/S8001/50#SCK	EXACT™/5000	PVL	Next Day
78403*	2.3 Mil White BOPP TC/S8001/50#SCK	EXACT™/5000	NEE	Next Day
77921*	2 Mil Clear PET TC/S8025/50#SCK	EXACT™/5000	NEE	Next Day
79648*	4 Mil Vinyl TCD/S8025/50#SCK	Stock 54/1668	PVL	Next Day
		EXACT™/5000	QTN, NEE, PTC, FTW, WCT	Next Day
18328	60# Semi-Gloss Elite™/R5195/40#SCK	EXACT™/10000		Next Day
		EXACT™/5000		Next Day
78149	2.3 Mil White BOPP TC/R3500/40#SCK	EXACT™/5000	PVL	Next Day
78826	2 Mil Clear BOPP TC/R1490/1.2 Mil PET	Stock 54/1668	NEE	Next Day
79325*	1 Mil Clear UV PET/S3000/1 Mil PET	Stock 54/1668	PVL	Next Day

*UL®-recognized
**UL®-recognition pending

NEE=Neenah, WI PVL=Painesville, OH WCT=West Coast
QTN=Quakertown, PA PTC=Peachtree City, GA FTW=Fort Wayne, IN

Select Solutions™ Kiddie Sticker Portfolio

Label constructions that help put smiles on faces

Portfolio Characteristics

- Thin and flexible
- Excellent dimensional stability
- Materials inherently printable with a variety of processes from flexo to digital
- Suitable for die cutting, laser cutting and embossing
- Ready-to-roll, lay-flat liner suited for sheet applications
- Adhesives compliant with toxicity standard

Applications

- Books
- Toys and games
- Promotional materials



Spec#	Product Description	Width/Length (In./Ft.)	Location	Lead Time
18392	60# Archival Semi-Gloss/S490/40#LF	EXACT™/10000	FTW	Next Day
18559	60# Archival Semi-Gloss/R5195/40#LF	13/10000	FTW	Next Day
		Ready Width™	FTW	Next Day
54116	54# Semi-Gloss FSC®/R5195/46#LF	EXACT™/15000	NEE	Next Day
79374	2.3 Mil White BOPP TC/S490/69#LF	60/2500	PVL	5 Days
17311	2.3 Mil White BOPP TC/R195/65#LF	60/2500	PVL	4 Days
53623	MaxFlex™ Silver/S490/69#MF	60/2500	PVL	4 Days
53676	MaxFlex™ Silver/R195/65#MF	60/1668	PVL	9 Days

FTW=Fort Wayne, IN PVL=Painesville, OH NEE=Neenah, WI

Select Solutions™ Lawn and Garden

Designed for a breadth of applications, the portfolio's materials have been designed to meet the durability and versatility the outdoors demand

Portfolio Characteristics

- All specifications are UL 969 and cUL C22.2 recognized
- Weather- and temperature-resistant
- Impervious to contact with aggressive chemicals, including oils and gasoline
- Reliable adhesion performance on rough, dusty and oily surfaces
- Excellent adhesion on low surface energy substrates

Applications

- Lawn mowers
- Chain saws
- Snow blowers
- Rototillers and more



Spec#	Product Description	Width/Length (In./Ft.)	Location	Lead Time
79453	Fasson® 2 Mil White PET TC/S8049/50#SCK	Stock 54/1668	PVL	Next Day
77920	Fasson® 2 Mil White PET TC/S8025/50#SCK	EXACT™/5000	NEE	Next Day
78385	Fasson® 2 Mil White PET TC/S800150#SCK	EXACT™/5000	NEE	Next Day
78668	Fasson® 2 Mil Matte Chrome PET ITC/S8025/50#SCK	Custom Coat/5000	FTW	4 Days
78670	Fasson® 2 Mil Bright Chrome PET ITC/S8025/50#SCK	Custom Coat/5000	FTW	5 Days
79590	Fasson® 4 Mil White Vinyl/S730/50#SCK	Run & Hold	PVL	Next Day
75849	Fasson® 3 Mil Velvet Lexan/S730/1.5 Mil PET	EXACT™/1668	NEE	Next Day
75850	Fasson® 5 Mil Velvet Lexan/S730/1.5 Mil PET	EXACT™/1668	NEE	Next Day
77844	Fasson® 1 Mil Clear PRT PET/S8020/40#BG Overlaminare	EXACT™/2500	NEE/PVL	Next Day
79325	Fasson® 1 Mil Clear UV PET/S3000/1 Mil PET Overlaminare	Stock 60/1668	PVL	Next Day
77843	Fasson® 1 Mil Matte PET/S8020/40#BG Overlaminare	Stock 60/1668	PVL	Next Day

NEE= Neenah, WI PVL=Painesville, OH FTW=Fort Wayne, IN

Select Solutions™ Lay-Flat Liner Portfolio

Wide range of adhesive material and adhesive options for roll-to-sheet and fanfold label applications

Portfolio Characteristics

- Wide range of material options including films, papers, holographics and more
- Permanent and removable adhesives of varying strengths
- Non-curling, non-distortion liners of various weights

Applications

- Sheeted labels
- Security and safety labels
- Inventory labels
- Shipping and handling labels
- Fanfold labels



Spec#	Product Description	Width/Length (In./Ft.)	Location	Lead Time
18559	60# Archival SG/R5195/40#LF	Ready Width™ 13/10000	FTW	Next Day
		78/1668	FTW	Next Day
18392	60# Archival SG/S490/40#LF	EXACT™/10000	FTW	Next Day
19862	Semi-Gloss Elite™ FasCover™/AT20M/69#MF	60/2500	PVL	4 Days
53569	TT1C/S4600/69#MF	60/2500	PVL	4 Days
53568	DT300HD/S4600/69#MF	60/2500	PVL	4 Days
53676	MaxFlex™ Silver/R195/69#MF	60/1668	PVL	Next Day
79267	2 Mil Clear BOPP TC/S692N/69#MF	60/2500	PVL	4 Days
79269	2 Mil Clear BOPP TC/S8001/69#MF	60/2500	PVL	4 Days
79270	2.3 Mil White BOPP TC/S692N/69#MF	60/2500	PVL	4 Days
17311	2.3 Mil White BOPP TC/R195/65#MF	60/2500	PVL	4 Days
79274	2.6 Mil White BOPP TC/S692N/69#MF	60/2500	PVL	4 Days
72944	Primax® 350/R143/65#MF	54/2500	PVL	5 Days
79282	FasClear® 250/S2501/69#MF	60/2500	PVL	4 Days
73000	FasClear® 350/R143/65#MF	54/2500	PVL	5 Days
79259	2 Mil Clear Print Treated PET/S8001/69#MF	60/2500	PVL	4 Days
79287	2 Mil White Print Treated PET/S4600/69#MF	60/2500	PVL	4 Days
79256	2 Mil White Print Treated PET/S8001/69#MF	60/2500	PVL	4 Days
79265	3 Mil Synthetic Paper/S8001/69#MF	60/2500	PVL	4 Days

FTW=Fort Wayne, IN PVL=Painesville, OH

Select Solutions™ Outdoor Overlaminates Portfolio

New specialized overlaminates offer longer-lasting legibility for critical product messaging

Portfolio Characteristics

- Enhanced durability, superior conformability excellent abrasion resistance for applications which require two-, three-, or even five-year durability
- Testing has been conducted on all elements of the label construction including inks, overlaminates and base label material to ensure performance

Applications

- Harsh environments and tough outdoor exposures to items, such as: heat, cold, rain, snow, chemicals, lubricating oils or gasoline



Spec#	Product Description	Width/Length (In./Ft.)	Location	Lead Time
80051	2 Mil Cast Gloss Vinyl/S659/1.5 Mil PET	Stock 60/300	PVL	Next Day
80052	3 Mil Calendered Gloss Vinyl/S8072P/1.5 Mil PET	Stock 60/300	PVL	Next Day
80053	1.5 Mil Gloss Urethane/S659/1.5 Mil PET	Stock 60/300	PVL	Next Day
80054	3 Mil Calendered Matte Vinyl/S8072P/1.5 Mil PET	Stock 60/300	PVL	Next Day

PVL=Painesville, OH

Xe Arc Testing with TT Ribbon (DNP R510HF) - PVC Base

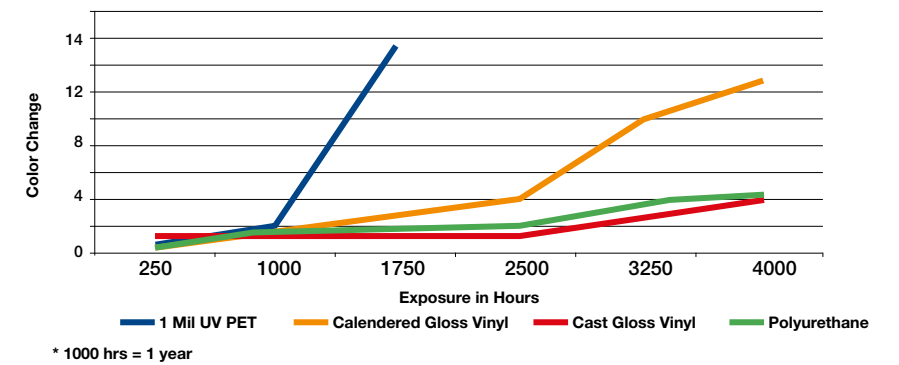

Xe Arc Testing UV Flexo Ink (Black) - PVC Base

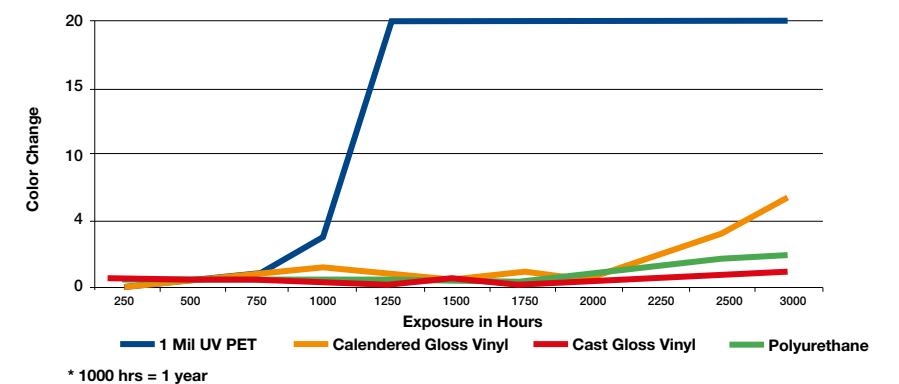

Avery Dennison Rapid-Roll® Flexible Packaging Portfolio

Flexible film packaging solutions for on-the-go convenience and single-use portions

Applications

- Consumer packaged goods
- Food & beverage
- Health & beauty
- Nutraceutical



Portfolio Characteristics

- Rapid-Roll FlexPak™ Portfolio features both film-faced and paper-faced pouch materials
- High-barrier sealant films keep contents safely inside
- Select from single-ply to multi-ply lamination combinations to best fit your needs
- Converting and co-packer education and testing available
- High-impact graphic capability for maximum branding and shelf appeal
- Visit label.averydennison.com/rapidroll for the complete flexible packaging portfolio offering

Spec#	Product Description	Location	Lead Time
54025	ChemControl Ultra	NEE	Next Day
54026	ChemControl Ultra Plus	NEE	Next Day
79537	ChemControl Premium Ultra	NEE	Next Day
79340	White StickPak LDPE 280 HB	NEE	Next Day
78432	White StickPak Metallocene 300 HB	NEE	Next Day
78831	Silver StickPak Metallocene 300 HB	NEE	Next Day
79343	White StickPak Surlyn® 280 HB	WCT	Next Day
79344	Silver StickPak Surlyn® 280 HB	NEE	Next Day
79778	Easy Open WH Cello StickPak Surlyn®	NEE	Next Day
79345	Easy Open WH OPS StickPak Surlyn® Co-Ex 300 HB	NEE	Next Day

NEE= Neenah, WI WCT=West Coast

Select Solutions™ Security Portfolio

Anti-tamper and anti-counterfeit solutions reinforce quality and assure authenticity

Portfolio Characteristics

- Customizable UV and IR print options
- Enhanced thermal transfer graphic solutions
- Chemical resistant coating for liquid products
- Adhesion to a wide range of substrates including paper, cardboard, metals, plastics, glass and even fabrics

Applications

- Home and personal care
- Consumer packaged goods
- Pharmaceutical
- Automotive
- Medical
- Durable goods
- Tamper evident





Spec#	Product Description	Width/Length (In./Ft.)	Location	Lead Time
Tamper Evident Paper				
19348	Fasson® Tamper Resistant Litho/S814/40#SCK	EXACT™/5000	PVL	Next Day
53581	Tamper-Resistant Litho/S8015/1.2 Mil PET	60/2500	PVL	4 Days
Void				
78194	Fasson® 2 Mil White Void Polyester TC/S8015W/50#SCK	EXACT™/1668	NEE	Next Day
78195	Fasson® 2 Mil Silver Void Polyester TC/S8015/50#SCK	EXACT™/1668	NEE	Next Day
78196	Fasson® 2 Mil Matte Chrome Void Polyester TC/S8015/50#SCK	54/1000	PVL	4 Days
Frangible Film				
79449	Fasson® 2 Mil Tamperfas™ Satin Vinyl/S730/50#SCK	48"/1668	PVL	Next Day
60097	Fasson® 2 Mil Clear Acetate/S730/50#SCK ABC	52/1668	PVL	Next Day
60091	Fasson® 1.5 Mil Clear Acetate/S730/50#SCK	52/5000	PVL	10 Days
SharpTear™				
77964	Fasson® 3 Mil Clear MDO/S692N/1.2 Mil PET	EXACT™/10000	QTN	Next Day
77980	Fasson® 3 Mil White MDO/S692N/1.2 Mil PET	EXACT™/10000	NEE	Next Day

NEE= Neenah, WI PVL=Painesville, OH QTN=Quakertown, PA

Select Solutions™ Reclosure Portfolio

Cost-effective, user-friendly resealing alternatives combining convenience with branding

	<p>Applications: Dry Conditions (dry foods, cookies, crackers)</p> <p>Adhesive: R3400</p>	<ul style="list-style-type: none"> » Easy Peel Back » Low Odor » Meets FDA 175.105 requirements
	<p>Applications: Damp Conditions (deli meats)</p> <p>Adhesive:</p> <ul style="list-style-type: none"> • R3500 • R3525 - 25% higher peel than R3500 	<ul style="list-style-type: none"> » Economical Alternative » Good Initial Tack » More “grab” than R3400 » Low Odor » Meets FDA 175.105 requirements
	<p>Applications: High Moisture Conditions (wet wipes, cleaning pads, facial wipes)</p> <p>Adhesive: R1490 – High-Performance, Approved for Direct Food Contact</p>	<ul style="list-style-type: none"> » Stable, Smooth Peel Back » Low Odor » Excellent Adhesion Rebuild » Broad Substrate Performance » NEW FCN 1716 Direct Food Contact and Reheating of Prepared Food Compliant

Available with white and clear top coated BOPP. Available custom facestocks for tailored solutions. For other FDA requirements please contact your Avery Dennison representative.

Spec#	Product Description	Width/Length (In./Ft.)	Location	Lead Time
78632	Fasson® 2.3 Mil White BOPP TC/R3400/1.2 Mil PET	60/1668	PVL	Next Day
78860	2 Mil CL BOPP TC/R3400/1 Mil PET	60/1668	PVL	Next Day
79657	Fasson® 2 Mil MET BOPP TC/R3400/1.2 Mil PET	60/1668	PVL	4 Days
78149	Fasson® 2.3 Mil White BOPP TC/R3500/40#SCK	EXACT™/5000	PVL	Next Day
78148	Fasson® 2 Mil Clear BOPP TC/R3500/40#SCK	EXACT™/5000	NEE	Next Day
77461	Fasson® 2.3 Mil White BOPP TC/R3500/1.2 Mil PET	EXACT™/10000	PVL	Next Day
77462	Fasson® 2 Mil Clear BOPP TC/R3500/1.2 Mil PET	EXACT™/15000	PVL	Next Day
79625	Fasson® 2 Mil CL BOPP TC/R3525/1.2 Mil PET	60/1668	PVL	4 Days
78826	Fasson® 2 Mil Clear BOPP TC/R1490/1.2 Mil PET	60/1000 54/1668	PVL NEE	7 Days Next Day
79008	Fasson® 2.3 Mil White BOPP TC/R1490/1.2 Mil PET	60/1000	PVL	7 Days
77652	Fasson® 2.3 Mil White BOPP TC/R143/1.2 Mil PET	60/1000	PVL	Next Day
78578	Fasson® 2 Mil Clear BOPP TC/R143/1.2 Mil PET	54/1668 60/1000	NEE PVL	Next Day 7 Days

NEE = Neenah, WI PVL = Painesville, OH
Single Slit Roll Service Program: Available in any width by 2500 ft. (3 in. core)

Select Solutions™ Removables Portfolio

A proven core of multipurpose products, featuring general purpose and application solution adhesives, that address a range of application needs from simple to complex

Portfolio Characteristics

- More than 40 label constructions featuring nine adhesives that include technologies such as microsphere, solvent acrylic, emulsion acrylic and hot melt rubber
- Designed to perform in specific applications on various substrates, such as: plastic, glass, metal and paper

Applications

- Household items
- Reclosure
- Furniture
- Consumer electronics
- Credit/Debit cards



Continued →

Paper

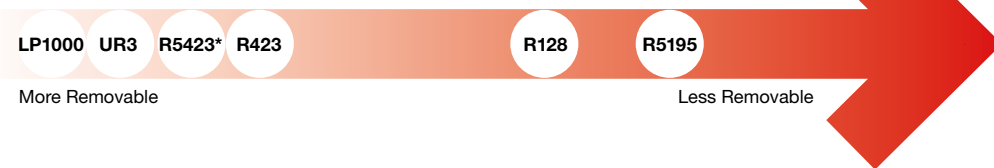

Removable Adhesives for Paper Components

General Purpose	
R5195	General purpose removable adhesive featuring moderate initial tack and minimal adhesion build over time. Its consistent level of adhesion and long-term removability make it suitable for applications on substrates such as glass and plastics. Proven successful for shelf and tote marking used in logistical tracking.
Application Solution	
UR3	Ultra-removable microsphere adhesive, featuring a consistent level of adhesion, as well as long term removability and repositionability across a wide variety of substrates. Fasson® UR3 remains removable for months with peel and reseal characteristics that provide consistent, secure positioning and clean removability.
LP1000	Ultra removable adhesive, featuring long-term, clean removability across wide variety of substrates. It offers economical solution for various opportunities. Designed to offer smooth peel and excellent die cutting and stripping characteristics. Particularly suited for applications like: retail information labels, inventory management or work-in-progress, point of sale promotions, newspapers, promotional labels, books, housewares, credit cards or glass.
R423/R5423	Removable, low peel adhesive featuring long-term removability, and excellent die cutting and stripping characteristics. Particularly suited for wallpaper promotional labels, high gloss book covers and shelf marking. R5423 is an excellent solution for Monroney labels.
R128	Removable rubber-based adhesive with high initial tack, internal strength and stable adhesion. R128 is recommended where clean removability is of primary importance. Adhesive can be used on a variety of substrates including glass, metal, plastic and others.

		Removable				
		UR3	LP1000	R423	R128	R5195
Adhesive Technology		Emulsion Acrylic (Microsphere)	Emulsion Acrylic	Emulsion Acrylic	Hot Melt Rubber	Emulsion Acrylic
Minimum Application Temperature, °F		20	10	10	10	40
Service Temperature Range, °F		-40 to 160	-40 to 160	-40 to 160	-65 to 120	-40 to 160
Food Contact		Indirect	Indirect	Indirect	Indirect	Indirect
Peel* (PE/Stainless)		.52/.40	.28/.37	.60/.52	.74/.55	.73/.91
Tack* (PE/Stainless)		.60/.93	.01/.42	.25/.53	1.0/1.3	1.1/1.4
Plastic	Polypropylene (PP)	█	█	█	█	█
	Polyethylene - High Density (HDPE)	█	█	█	█	█
	Polyethylene Terephthalate (PET)	█	█	█	█	█
Glass	Polyethylene Coated	█	█	█	█	█
	Window (annealed)	█	█	█	█	█
	Automotive (tempered)	█	█	█	█	█
Metal	Powder Coated (smooth PET)	█	█	█	█	█
	Painted (alkyd enamel)	█	█	█	█	█
	Stainless Steel	█	█	█	█	█
Paper	Recycled Corrugated	█	█	█	█	█
	Bond (uncoated)	█	█	█	█	█
	Glossy (coated)	█	█	█	█	█

Based on 6 week testing of practical removability rating and failure mode

*Peel and tack are measured in lb./inch

█ Recommended - Test in actual application
 █ Recommended - Tighter adhesion
 █ Not Recommended

Paper Products and Service Programs

Spec#	Product Description	Width/Length (In./Ft.)	Location	Lead Time
R5195				
18303	Fasson® Laser Copy™ Jet/R5195/45#LF	EXACT™/10000	FTW	Next Day
18327	Fasson® Trans-Therm®1C/R5195/40#CK	EXACT™/10000	FTW, DAL, SEA	Next Day
18328	Fasson® 60# Semi-Gloss Elite™/R5195/40#SCK	EXACT™/5000	FTW, QTN, PTC, NEE, WCT	Next Day
		EXACT™/10000	SEA	Next Day
18329	Fasson® 50# DSX™/R5195/50#CK	EXACT™/10000	FTW	Next Day
18444	Fasson® Matte Litho/R5195/40#SCK	EXACT™/2500	FTW	Next Day
18445	Fasson® 60# Cast Gloss/R5195/40#SCK	EXACT™/10000	FTW	Next Day
18558	Fasson® DT200GP/R5195/40#CK	EXACT™/10000 EXACT™/15000	FTW, MTL	Next Day
18559	Fasson® 60# Archival Semi-Gloss/R5195/40#LF	78/1668 Ready Width™ 13/10000	FTW	Next Day
18685	Fasson® DT200HD Plus/R5195/40#CK	EXACT™/5000/10000	FTW	Next Day
54116	Fasson® 54# Semi-Gloss FSC®/R5195/46#LF	EXACT™/15000	NEE	Next Day
UR3				
53421	Fasson® High Gloss Plus/UR3/40#SCK	EXACT™/5000	PVL	Next Day
53432	Fasson® Trans-Therm®/UR3/40#SCK	EXACT™/5000	PVL	Next Day
54125	Fasson® Semi Gloss Plus/UR3/40#SCK	EXACT™/5000	PVL	Next Day
LP1000				
54148	Fasson® DT 200HD FSC/LP1000/40#SCK	EXACT™/5000	PVL	Next Day
54149	Fasson® 60# Semi-Gloss /LP1000/40#SCK	EXACT™/5000	PVL	Next Day
R423/R5423				
19714	Fasson® Semi-Gloss Elite™/R423/40#SCK	60/1668	PVL	Next Day
96546	Fasson® 60# Cast Gloss/R423/40#SCK	60/1668	PVL	Next Day
98203	Fasson® Trans-Therm® 1C/R423/40#SCK	60/1668	PVL	Next Day
18345	Fasson® Standard Laser-Rite™/Std R5423/50#MF	EXACT™/10000	FTW	Next Day
53763	Fasson® Durable Laser-Rite™ FSC®/R5423/50#MF	EXACT™/5000	FTW	Next Day
R128				
01991	Fasson® 50# DSX™/R128/50#SCK	30/1500	PTC	4 Days
07607	Fasson® High Gloss Plus/R128/40#SCK	60/1550	PTC	Next Day
07719	Fasson® High Gloss Plus/R128/50#SCK	30/1550	PTC	4 Days
15931	Fasson® Semi-Gloss Elite™/R128/40#SCK	30/1500	PTC	4 Days
96088	Fasson® Trans-Therm® 1C/R128/40#SCK	30/1667	PTC	6 Days
96174	Fasson® Trans-Therm® 2C/R128/40#SCK	30/1500	PTC	4 Days
19342	Fasson® Trans-Therm® 1C FasCover™ 2/R128/40#SCK	30/1500	PTC	4 Days
13645	Fasson® FasPrism™ Iridescent/R128/40#SCK	30/1500	PTC	4 Days

DAL=Dallas, TX FTW=Fort Wayne, IN WCT=West Coast PVL=Painesville, OH PTC=Peachtree City, GA

QTN=Quakertown, PA SEA=Seattle, WA NEE=Neenah, WI

Film

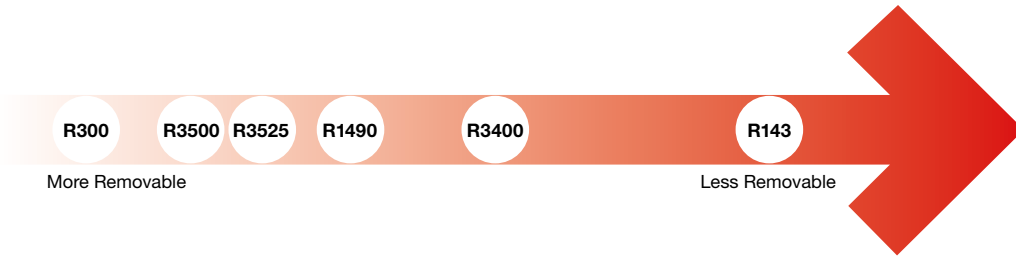

Removable Adhesives for Film Components

General Purpose	
R3500	Specially formulated acrylic adhesive designed for ease of removability from plastic packaging while maintaining good peel performance. Suitable for many general-purpose applications.
Application Solution	
R143	Specially formulated acrylic removable adhesive with versatile performance properties. Specific applications include durables, electronics assembly labeling and reclosures.
R1490	Specially formulated low odor acrylic adhesive with clean removability properties and a smooth, low noise peel. Smooth peel from flow-wraps, olefins and other plastics. Suitable for reclosure applications.
R300	Ultra removable clear adhesive, suitable in applications requiring long-term removability. Particularly well suited for CD/DVD security labeling, oil change labels, housewares and glass.
R3400	Removable adhesive featuring moderate initial tack and minimal adhesion build over time. It offers a consistent level of adhesion and long-term removability across a variety of substrates. An excellent choice for resealable packaging and multi-use labels. Suitable for wide range of substrates and applications.
R3525	Specially formulated acrylic adhesive designed for ease of removability from plastic packaging while maintaining good peel performance. Suitable for many general-purpose applications.

		Removable					
		R300	R3500	R3525	R3400	R1490	R143
Adhesive Technology		Emulsion Acrylic			Solvent Acrylic		
	Minimum Application Temperature, °F	45	40	40	40	50	50
	Service Temperature Range, °F	-40 to 176	0 to 200	0 to 200	-40 to 176	-40 to 250	-40 to 250
	Food Contact	Indirect	Indirect	Indirect	Indirect	Direct	Pending
	Peel* (PE/Stainless)	0.14/0.47	0.25/0.78	0.31/0.98	0.41/0.92	0.32/0.96	0.49/1.39
	Tack* (PE/Stainless)	0.44/0.71	0.56/1.12	0.70/1.40	0.72/1.27	0.56/1.49	0.99/2.20
Plastic	Polypropylene (PP)	█	█	█	█	█	█
	Polyethylene - High Density (HDPE)	█	█	█	█	█	█
	Polyethylene terephthalate (PET)	█	█	█	█	█	█
Glass	Polyethylene coated	█	█	█	█	█	█
	Window (annealed)	█	█	█	█	█	█
	Automotive (tempered)	█	█	█	█	█	█
Metal	Powder coated (smooth PET)	█	█	█	█	█	█
	Painted (alkyd enamel)	█	█	█	█	█	█
	Stainless Steel	█	█	█	█	█	█
Paper	Recycled Corrugated	█	⊘	⊘	⊘	⊘	⊘
	Bond (uncoated)	█	⊘	⊘	⊘	█	⊘
	Glossy (coated)	⊘	⊘	⊘	⊘	⊘	⊘

Based on 6 week testing of practical removability rating and failure mode

*Peel and tack are measured in lb./inch

█ Recommended - Test in actual application
 █ Recommended - Tighter adhesion
 ⊘ Not Recommended

Film Products and Service Programs

A list of our featured removable film constructions and service programs. Based on customer input and insight from Avery Dennison experts, the offering continues to evolve. If you are seeking a product that is not listed, please contact your sales or technical representative for information about our custom product development program - Engineered Solutions.

Spec#	Product Description	Width/Length (In./Ft.)	Location	Lead Time
R3500				
77461	Fasson® 2.3 Mil White BOPP TC/R3500/1.2 Mil PET	EXACT™/10000	NEE	Next Day
77462	Fasson® 2 Mil Clear BOPP TC/R3500/1.2 Mil PET	EXACT™/15000	NEE	Next Day
78148	Fasson® 2 Mil Clear BOPP TC/R3500/40#SCK	EXACT™/5000	NEE	Next Day
78149	Fasson® 2.3 Mil White BOPP TC/R3500/40#SCK	EXACT™/5000	PVL	Next Day
R143				
75394	Fasson® Primax® 350/R143/1.5 Mil PET	EXACT™/5000	PVL	Next Day
77967	Fasson® Primax® 350/R143/50#SCK ABC	EXACT™/5000	PVL	Next Day
78578	Fasson® 2 Mil Clear BOPP TC/R143/1.2 Mil PET	60/1000	PVL	Next Day
77652	Fasson® 2.3 Mil White BOPP TC/R143/1.2 Mil PET	54/2500	PVL	5 Days
R1490				
79008	Fasson® 2.3 Mil White BOPP TC/R1490/1.2 Mil PET	60/1000	PVL	7 Days
R300				
75150	Fasson® 2 Mil Clear BOPP TC/R300/1 Mil PET	60/1668	PVL	Next Day
77563	Fasson® 2.6 Mil White BOPP TC/R300/40#BG	EXACT™/5000	PVL	Next Day
R3400				
78201	Fasson® 2 Mil Clear BOPP TC/R3400/40#BG	60/1668	PVL	Next Day
78632	Fasson® 2.3 Mil White BOPP TC/R3400/1.2 Mil PET	60/1668	PVL	Next Day
78860	Fasson® 2 Mil Clear BOPP TC/R3400/1 Mil PET	60/1668	PVL	Next Day
R3525				
79625	Fasson® 2 Mil CL BOPP TC/R3525/1.2 Mil PET	60/1668	PVL	4 Days

PVL=Painesville, OH NEE=Neenah, WI

Select Solutions™ Safety and Warning Labels Portfolio

Reliable solutions designed to perform on a broad range of surfaces commonly subjected to climate or chemical exposure

Portfolio Characteristics

- Reliable adhesion performance on rough, dusty and oily surfaces
- Weather- and temperature-resistant
- Impervious to contact with aggressive chemicals, oils and gasoline
- Highly adaptable to varying surface and application conditions
- Materials suitable for thermal transfer, digital and laser printing

Applications

- Appliances
- Lawn and garden
- Automotive
- Electronics
- Medical device applications



Spec#	Product Description	Width/Length (In./Ft.)	Location	Lead Time
79453	Fasson® 2 Mil White PET TC/S8049/50#SCK	Stock 54/1668	PVL	Next Day
77920	Fasson® 2 Mil White PET TC/S8025/50#SCK	EXACT™/5000	NEE	Next Day
78385	Fasson® 2 Mil White PET TC/S8001/50#SCK	EXACT™/5000	NEE	Next Day
77922	Fasson® 2 Mil Matte Chrome PET TC/S8025/50#SCK	EXACT™/5000	FTW	4 Days
78403	Fasson® 2.3 Mil White BOPP TC/S8001/50#SCK	EXACT™/5000	NEE	Next Day
79653	Fasson® 2 Mil White PET TC/S8049/EZ Liner	Stock 55/2500	PVL	5 Days
79651	Fasson® 4 Mil White Vinyl/S8025/EZ Liner	Stock 55/2500	PVL	5 Days
79246	Fasson® 4 Mil White Vinyl/S8025/50#SCK	Custom Coat/5000	FTW	4 Days
75849	Fasson® 3 Mil Velvet Lexan®/S730/1.5 Mil PET	EXACT™/1668	NEE	Next Day
75850	Fasson® 5 Mil Velvet Lexan®/S730/1.5 Mil PET	EXACT™/1668	NEE	Next Day
79325	Fasson® 1 Mil Clear UV PET/S3000/1.0 Mil PET Overlaminates	Stock 60/1668	PVL	Next Day
77843	Fasson® 1 Mil Matte PET/S8020/40#BG Overlaminates	Stock 60/1668	PVL	Next Day

NEE=Neenah, WI PVL=Painesville, OH FTW=Fort Wayne, IN

Select Solutions™ Overlaminates Portfolio

An extensive collection of overlaminates, including Lexan®, clear print-treated, clear topcoated, clear UV and matte polyesters, built for a variety of end use applications

Portfolio Characteristics

- UL®-Recognized
- Tested to meet the requirements of a variety of environments, conditions, temperatures and OEM standards
- Ability to stiffen a construction for better application alignment creating a flush, no-label look



Spec#	Product Description	Width/Length (In./Ft.)	Location	Lead Time
75859	Fasson® 3 Mil Velvet Lexan®/S730/1.5 Mil PET	EXACT™/1700	NEE	Next Day
75850	Fasson® 5 Mil Velvet Lexan®/S730/1.5 Mil PET	EXACT™/1700	NEE	Next Day
77955	Fasson® 1 Mil Clear Print-Treated Polyester/S8020/1 Mil PET	EXACT™/2500	NEE	Next Day
77842	Fasson® 1 Mil Clear TC Polyester/S8020/1 Mil PET	60/1668	NEE, PVL	1-2 Days
77844	Fasson® 1 Mil Clear Print-Treated Polyester/S8020/40#BG	EXACT™/2500	PVL, WCT	Next Day
77843	Fasson® 1 Mil Matte Polyester/S8020/40#BG	EXACT™/5000	PVL	Next Day
77841	Fasson® 1 Mil Clear TC Polyester/S8020/40#BG	60/1668	PVL	1-2 Days
		Ready Width™ 6/5000	PVL	1-2 Days
		Ready Width™ 12/5000	PVL	1-2 Days
77845	Fasson® 2 Mil Clear Print-Treated Polyester/S8020/40#BG	Custom Coat 60/5000	PVL	8-10 Days
77854	Fasson® 2 Mil Clear TC Polyester/S8020/40#BG	Custom Coat 60/5000	PVL	8-10 Days
79325	Fasson® 1 Mil Clear UV PET/S3000/1 Mil PET	60/1668	PVL	1-2 Days
77855	Fasson® 1 Mil Clear TC Polyester/S730/1 Mil PET	EXACT™/5000	NEE	Next Day

NEE=Neenah, WI PVL=Painesville, OH WCT=West Coast FTW=Fort Wayne, IN

Select Solutions™ Tag Stock Portfolio

Multipurpose for multitasking

Portfolio Characteristics

- Consistent adherence to uneven substrates and fabrics
- Apparel friendly; removes cleanly from fabrics
- Stiffness and high internal strength for more challenging applications

Applications

- Sock bands and garment labels
- Retail price tickets
- Information labels
- Work-in-process labels



Spec#	Product Description	Width/Length (In./Ft.)	Location	Lead Time
00582	8 Pt. Tag/HMR/40#SCK	30/1500	PTC	4 Days
07541	8 Pt. Tag/R195/40#SCK	60/2500	PVL	5 Days
15258	8 Pt. Tag/AT20/40#SCK	EXACT™/5000	FTW	Next Day
17375	8 Pt. Tag/AT20A/40#SCK	EXACT™/5000	FTW	Next Day
17698	8 Pt. Tag/S246/40#SCK TNR	EXACT™/5000	PTC, NEE	Next Day
54047	10 Pt. Tag FSC®/AT20A/40#SCK	EXACT™/5000	FTW	Next Day
01021	8 Pt. Dry Tag	30/1500	PTC	4 Days
53539	8 Pt. Tag/S4600/40#SCK	60/2500	PVL	4 Days

FTW=Fort Wayne, IN NEE=Neenah, WI PVL=Painesville, OH PTC=Peachtree City, GA

Select Solutions™ Transfer Tape Portfolio

From general-purpose tapes to custom engineered materials, Avery Dennison will work with you to create valuable solutions to meet your needs.

Portfolio Characteristics

- Multiple Transfer Tapes and adhesives
- Offered in 7.5", 10" and 15" rolls; must order full master of desired slit width
- .25" of ungummed area on each roll facilitates handling

Applications

RFID application for logistics and transport

Food and retail promotions



Spec#	Product Description	Width/Length (In./Ft.)	Location	Lead Time
19188	FF 40#SCK/S490/40#SCK	60/2500	PVL, DAL	Next Day
19052	FF 40#SCK/At20/40#SCK	60/2500	PVL	5 Days
98819	FF 40#SCK/S246/40#SCK	30/2500	PTC	4 Days
78763	FF 40#SCK EZ/S490A/1.5 Mil PET	60/2500	PVL	4 Days

PVL=Painesville, OH PTC=Peachtree City, GA DAL=Dallas, TX
*Actual usable width is .25" less than size posted due to ungummed edges.

Single Slit Roll Service Program

More services to help you serve your clients

Portfolio Characteristics

- Easy access to single rolls for 18 unique product specifications (and growing)
- You can service your client's needs in any width by 2,500-foot lengths
- Another new service offering is our Prototype program or experiment with a proposed Engineered Solution
- Our technical team has added new prototyping capabilities that allow us to quickly create unique, small prototype rolls within seven days

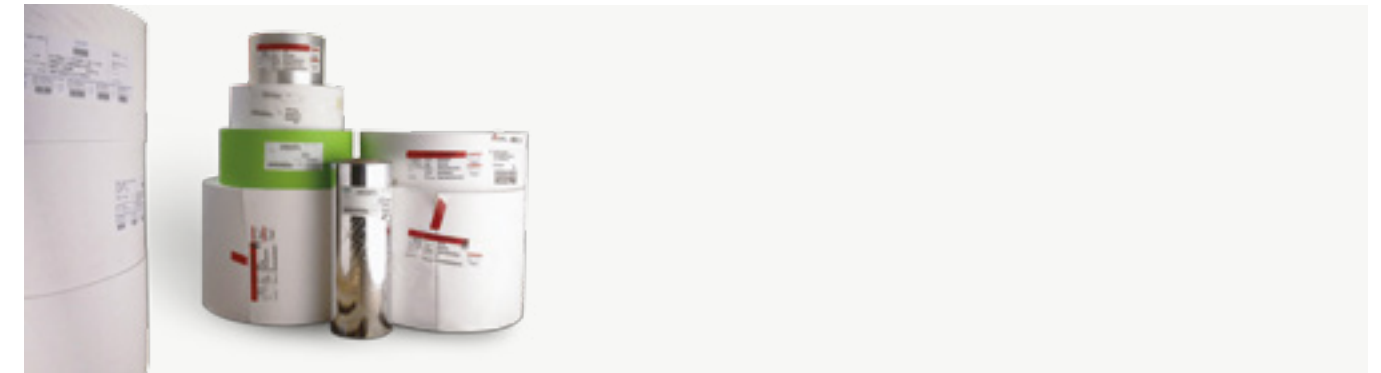

Single Slit Roll Service Program

Spec#	Description	Width/Length (In./Ft.)	Location	Lead Time	Portfolio
75312	Inverted-Face Metallized Primax® 250/S1000/44#PK	Single Roll*/2500	PVL	4 Days	Select Solutions™ Cover-Up
79348	5 Mil Matte White Kimdura® Inkjet/S4600/50#SCK	Single Roll*/2500	PVL	Next Day	Durables
79404	3 Mil Inkjet Synthetic Paper/S8001/50	Single Roll*/2500	PVL	Next Day	Durables
79453	2 Mil White PET TC/S8049/50#SCK	Single Roll*/2500	PVL	Next Day	Durables
79732	2 Mil White PET TC/S8029/50#SCK	Single Roll*/2500	PVL	Next Day	Select Solutions™ Automotive

PVL=Painesville, OH

*Single Slit Roll Service Program: Available in any width by 2500 ft. (3 in. core)

Select Solutions™ Mix & Match™ Product Guide

Versatile, flexible way to create select label solutions

Portfolio Characteristics

- Find the right construction fast
- Choose from a set range of label constructions
- Select from foils, films, metallized films, papers and more in combination with our best-performing adhesives
- Get the benefit of a customized label solution with low MOQs, quick pricing and rapid shipping



Mix & Match Adhesive Matrix

To help you better navigate our Mix & Match products, below is an easy-to-use and understand adhesive matrix. The matrix allows you to swiftly identify the correct adhesives for your applications.

		R423	R3400	S246	C2510	S490	S4600	S2501	S692N	S8001	S8015
Low Surface Energy		Good	Good	Good	Good	Good	Good	Good	Good	Good	Good
High Surface Energy		Good	Good	Good	Good	Good	Good	Good	Good	Good	Good
Tough Substrates		Good	Good	Good	Good	Good	Good	Good	Good	Good	Good
Curved (>1")		Good	Good	Good	Good	Good	Good	Good	Good	Good	Good
Curved (<1")		Good	Good	Good	Good	Good	Good	Good	Good	Good	Good



	40#SCK	50#SCK	40#BG	69#MF	1.2 Mil PET	1.5 Mil PET
Prime Paper						
60# Cast Gloss	S246	07655				07732
	C2510	53631				
	R423	96546		53876		
	S490		53614	07693		
Bright Silver Foil	S4600	53610	53615	53617	53621	
	S246		01734			
	C2510		53530			53510
	R423	53865				
Dull Silver Foil	S490			53578	53537	
	S246	02861	10751			53503
	C2510		53528			
	S4600	53540				
Bright Gold Foil	S246	53522				
	S246	53354	53635			53628
	C2510	53632				53626
	R423	53868				
MaxFlex™ Bright Silver	S490			53623		
	S246	53825				
Inverted-Face MaxFlex™ Bright Silver	S2501			53573		
	S4600	53539				
8 Pt. Tag						

Variable Information

TT1C	S246		14443			53507
	C2510	53527				53512
	R423	98203				
TT2C	S4600		53551		53569	
	S246		02329			
DT 300HD	R423	96029				
	S4600	53542		53559	53568	

Prime Film

2 Mil Clear BOPP TC	S692N				79267		79184
	S2501				79268	79164	
	R3400				79495		
	S8001			79234	79269	79153	
	S8015	79295	79305				

Continued →

All Mix & Match orders more than 5000 LF are subject to standard lead times

Blue Spec# = Ships from Peachtree City, GA, 30" x 1500' MOQ
Green Spec# = Ships from Painesville, OH, 60" x 2500' MOQ

	40#SCK	50#SCK	40#BG	69#MF	1.2 Mil PET	1.5 Mil PET
2.3 Mil White BOPP TC	S246	78788	79140			
	C2510		79141			
	R3400			79486	79496	
	S692N				79270	
	S2501		79205	79224	79272	79187
	S4600			79215		
	S8001			79235	79273	79154
2.6 Mil White BOPP TC	C2510	79142				
	S692N			79274		76999
	R3400			79487		
	S2501		79206		79276	79188
	S4600		79201	79216	79275	
	S8001			79236		
2 Mil Metallized BOPP TC	S8015		79315			
	S246	79143				
	C2510	79144				
	S2501				79285	
	S4600		79203	79218	79284	
	S8001		79211	79233	79266	
	S8015		79310			
Primax® 250	R3400				79657	
	S692N					76993
	S2501		79207		79280	79167
	R3400				79499	
	S8001		79213	79237	79281	
FasClear® 250	S2501				79282	
	S8001				79283	79180
	S8015	79299				

Durable Film

2 Mil Clear Print-Treated PET	S2501		79230			
	S8001				79259	79090
	R3400		79491			
2 Mil White Print-Treated PET	S4600		79219	79287		
	S8001				79256	79158
	S8015	79301		79319		79293
2 Mil Matte Chrome PET TC	R3400				79508	
	S2501				79260	
	S4600				79261	
3 Mil Synthetic Paper	S8001				79262	79159
	S2501				79263	
	S4600				79264	78427
	S8001	79199		79239	79265	79160
	S8015	79304				
	R3400		79494		79510	79519

All Mix & Match orders more than 5000 LF are subject to standard lead times

Blue Spec# = Ships from Peachtree City, GA, 30" x 1500' MOQ
Green Spec# = Ships from Painesville, OH, 60" x 2500' MOQ

Functional Packaging Crossword Quiz

Test your knowledge of functional packaging with this crossword puzzle.

Across

- 4 Makes separate parts and processes seamless packaging
- 5 Opposite of complex
- 8 Food containing health or medicinal benefits
- 11 A drink
- 12 A quality of being useful
- 14 Colors do this or another word for soda
- 15 A movie
- 17 To easily remove
- 18 Avery Dennison single-serve solution
- 19 Another word for pliable
- 21 In 1951 Franklin Moss conducted a poll that named this press

Down

- 1 A favorable circumstance
- 2 A person who makes or constructs units
- 3 A popular label method and one that provides easy application
- 6 Mintel study revealed this percent of consumers want packaging with additional benefits
- 7 Invented by the Chinese in 105 A.D.
- 9 Practical solution
- 10 To be safe
- 13 An advantage or accommodation
- 16 To close tightly or securely again
- 20 Abbreviation for Consumer Packaged Goods

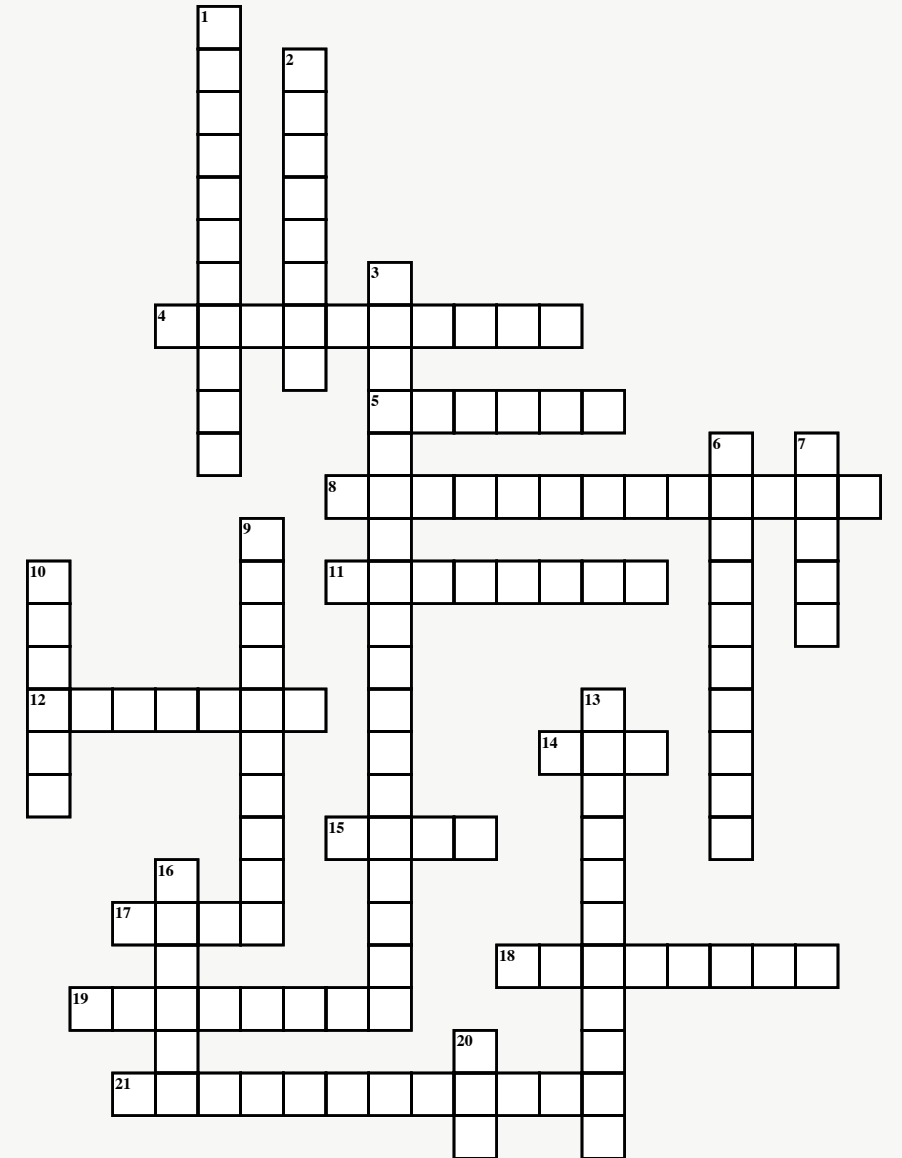

Answer Key on Back



8080 Norton Parkway
Mentor, Ohio 44060

PRESORTED
FIRST-CLASS MAIL
U.S. POSTAGE PAID
PAINESVILLE, OH
PERMIT NO. 958

Return Service Requested

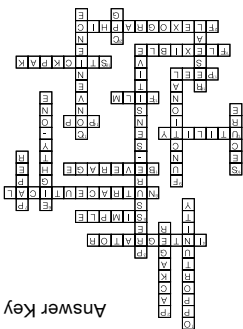

ADV# 369, 04/2018, 3500

©2018 Avery Dennison Corporation. All rights reserved. Fasson, and all other Avery Dennison brands, product names, codes and service program terms are trademarks of Avery Dennison Corporation.



Label and
Packaging Materials

North Asia

5th Floor, Hongye Park
1801 Hongmei Road,
Xuhui District 200233,
Shanghai, China
+86 21 33951888

**South Asia Pacific and
Sub-Saharan Africa**

460 Alexandra Road,
PSA Building
#28-02/03, Singapore 119963
+65 6430 7000

Europe

Willem Einthovenstraat 11
2342 BH Oegstgeest
The Netherlands
+31 85 000 2000

Latin America

Rodovia Vinhedo-
Viracopos, KM 77
CEP 13280-000
Vinhedo - SP, Brazil
+55 19 3876-7600

North America

8080 Norton Pkwy
Mentor, OH 44060
800.944.8511